

sysmocom

sysmocom - s.f.m.c. GmbH



OsmoBTS Abis Protocol Specification

by Neels Hofmeyr and Harald Welte

Copyright © 2015-2021 sysmocom - s.f.m.c. GmbH

Permission is granted to copy, distribute and/or modify this document under the terms of the GNU Free Documentation License, Version 1.3 or any later version published by the Free Software Foundation; with no Invariant Sections, no Front-Cover Texts, and no Back-Cover Texts. A copy of the license is included in the section entitled "GNU Free Documentation License".

The AsciiDoc source code of this manual can be found at <http://git.osmocom.org/osmo-gsm-manuals/>

HISTORY

NUMBER	DATE	DESCRIPTION	NAME
DRAFT 1.8.0-17-g64d9f	2024-Nov-09		NH

Contents

1	Introduction	1
2	Overview	1
2.1	Identities	2
3	IPA Multiplex	2
3.1	IPA Header	3
3.2	IPA Stream Identifiers	3
3.3	IPA Connection Management (CCM)	3
3.3.1	Identity Management	4
3.3.2	IPA CCM Messages	4
4	Organization & Maintenance Link (OML)	4
4.1	List of Messages	4
4.1.1	Messages Compliant With TS 52.021	4
4.1.2	Messages Specific to OsmoBTS	5
4.1.3	Messages Not Implemented by OsmoBTS	5
4.2	Details on Compliant OML Messages	7
4.2.1	SW Activated Report	7
4.2.2	Set BTS Attributes	7
4.2.3	Set Radio Carrier Attributes	8
4.2.4	Set Channel Attributes	8
4.2.5	State Changed Event Report	8
4.2.6	Change Administrative State	8
4.2.7	Opstart	9
4.2.8	Get Attributes	9
4.2.9	Get Attribute Response	9
4.3	Details on OsmoBTS Specific Messages	9
4.3.1	Set Attribute	9
4.4	Additional Object Classes	9
4.4.1	GPRS-NSE Managed Object	10
4.4.2	GPRS Cell Managed Object	10
4.4.3	GPRS NS-VC Managed Object	10
4.5	Information Elements Overview	10
4.5.1	IEs Conforming to TS 52.021	10
4.5.2	IEs Not Conforming to TS 52.021	12
4.5.3	Additional Attributes and Parameters	12
4.6	Details on IEs	13

4.6.1	HW Description	13
4.6.2	ARFCN List	13
4.6.3	Additional Channel Combinations	13
4.6.4	Connection Failure Criterion	14
4.6.5	TSC	14
4.6.6	RSL Destination IP Address	14
4.6.7	RSL Destination TCP Port	14
4.6.8	RSL IPA Stream ID	14
4.6.9	GPRS Routing Area Code	14
4.6.10	GPRS Paging Configuration	14
4.6.11	GPRS NSEI	14
4.6.12	GPRS BVCI	15
4.6.13	GPRS NSVCI	15
4.6.14	GPRS NS Configuration	15
4.6.15	GPRS BSSGP Configuration	15
4.6.16	GPRS NS Link Configuration	15
4.6.17	GPRS RLC Configuration	16
4.6.18	GPRS Coding Schemes	16
4.6.19	GPRS RLC Configuration 2	16
4.6.20	GPRS RLC Configuration 3	17
4.6.21	SW Configuration	17
4.6.22	Manufacturer Id	18
4.7	A-bis OML Initialization / BTS bring-up	18
4.7.1	Site Manager MO Initialization	19
4.7.2	BTS MO Initialization	20
4.7.3	Baseband Transceiver MO Initialization	21
4.7.4	Radio Carrier MO Initialization	22
4.7.5	Channel MO Initialization	23
4.7.6	Complete BTS Initialization Procedure	23
5	Radio Signalling Link (RSL)	27
5.1	List of Messages	27
5.1.1	Messages Compliant With TS 48.058	27
5.1.2	Messages Specific to OsmoBTS	28
5.1.3	Messages Not Implemented by OsmoBTS	29
5.2	Message Limitation Details	30
5.2.1	Channel Activation	30
5.2.2	Measurement Result	30
5.2.3	Mode Modify	30

5.2.4	MS Power Control	30
5.2.5	SACCH Info Modify	31
5.2.6	BCCH Information	31
5.2.7	Channel Required	31
5.2.8	Paging Command	32
5.2.9	RF Resource Indication	32
5.2.10	SACCH Filling	32
5.3	User Plane Transport Management	32
5.3.1	RSL Create Connection (CRCX)	33
5.3.2	RSL Modify Connection (MDCX)	33
5.3.3	RSL Delete Connection (DLCX)	33
5.3.4	RSL Delete Connection (DLCX) Indication	33
5.4	Dynamic Channel Combinations	33
5.4.1	IPA Style Dynamic Channels	34
5.4.1.1	PDCH Activate	34
5.4.1.2	PDCH Deactivate	34
5.4.1.3	IPA Style Dynamic Switchover Example	35
5.4.2	Osmocom Style Dynamic Channels	36
5.4.2.1	Osmocom Style Dynamic Switchover Example	37
5.5	ETWS (Earthquake and Tsunami Warning System)	38
5.6	BCCH carrier power reduction operation	38
5.7	Message Formats and Contents	39
5.7.1	Create Connection (CRCX)	39
5.7.2	Create Connection (CRCX) ACK	39
5.7.3	Create Connection (CRCX) NACK	39
5.7.4	Modify Connection (MDCX)	40
5.7.5	Modify Connection (MDCX) ACK	40
5.7.6	Modify Connection (MDCX) NACK	40
5.7.7	Delete Connection (DLCX) Indication	40
5.7.8	Delete Connection (DLCX)	41
5.7.9	Delete Connection (DLCX) ACK	41
5.7.10	Delete Connection (DLCX) NACK	41
5.7.11	PDCH Activate	41
5.7.12	PDCH Activate ACK	41
5.7.13	PDCH Activate NACK	42
5.7.14	PDCH Deactivate	42
5.7.15	PDCH Deactivate ACK	42
5.7.16	PDCH Deactivate NACK	43
5.7.17	Osmocom ETWS Command	43

5.8	Information Element Codings	43
5.8.1	A-bis/IP specific RSL Message discriminators	43
5.8.2	A-bis/IP specific RSL IEs	44
5.8.3	RSL_IE_CHAN_NR	44
5.8.4	RSL_IE_IPAC_REMOTE_IP	45
5.8.5	RSL_IE_IPAC_REMOTE_PORT	45
5.8.6	RSL_IE_IPAC_LOCAL_PORT	45
5.8.7	RSL_IE_IPAC_SPEECH_MODE	45
5.8.8	RSL_IE_IPAC_LOCAL_IP	45
5.8.9	RSL_IE_IPAC_CONN_STAT	45
5.8.10	RSL_IE_IPAC_CONN_ID	46
5.8.11	RSL_IE_IPAC_RTP_PAYLOAD2	46
5.8.12	RSL_IE_OSMO_REP_ACCH_CAP	46
5.8.13	RSL_IE_OSMO_TRAINING_SEQUENCE	46
5.8.14	RSL_IE_OSMO_TEMP_OVP_ACCH_CAP	47
5.8.15	RSL_IE_OSMO_OSMUX_CID	47
5.8.16	RSL_IE_IPAC_RTP_CSD_FORMAT	48
5.9	A-bis RSL Initialization / BTS bring-up	48
6	User-Plane Traffic via RTP	50
6.1	RTP Payload Formats	50
7	Glossary	50
A	Osmocom TCP/UDP Port Numbers	59
B	Bibliography / References	60
	B.0.0.0.1 References	60
C	GNU Free Documentation License	64
C.1	PREAMBLE	64
C.2	APPLICABILITY AND DEFINITIONS	64
C.3	VERBATIM COPYING	65
C.4	COPYING IN QUANTITY	65
C.5	MODIFICATIONS	66
C.6	COMBINING DOCUMENTS	67
C.7	COLLECTIONS OF DOCUMENTS	67
C.8	AGGREGATION WITH INDEPENDENT WORKS	67
C.9	TRANSLATION	68
C.10	TERMINATION	68
C.11	FUTURE REVISIONS OF THIS LICENSE	68
C.12	RELICENSING	68
C.13	ADDENDUM: How to use this License for your documents	69

1 Introduction

This document describes the A-bis interface of **OsmoBTS**. Based on 3GPP TS 12.21 and 08.58, this document indicates which of the 3GPP specified A-bis messages and IEs are implemented according to 3GPP specifications, which of these are not or not fully implemented, as well as OsmoBTS-specific extensions to the A-bis interface not specified by 3GPP.

Extensions to the A-bis interface specific to OsmoBTS are detailed in this document. For details on the messages and IEs that comply with above mentioned 3GPP specifications, please refer to those documents.

Table 1: 3GPP document versions referred to by this document

3GPP TS 08.56	version 8.0.1 Release 1999
3GPP TS 08.58	version 8.6.0 Release 1999
3GPP TS 08.60	version 8.2.1 Release 1999
3GPP TS 12.21	version 8.0.0 Release 1999

Table 2: IETF documents referred to by his document

IETF RFC 768	User Datagram Protocol
IETF RFC 791	Internet Protocol
IETF RFC 793	Transmission Control Protocol
IETF RFC 1889	RTP: A Transport Protocol for Real-Time Applications
IETF RFC 3551	RTP Profile for Audio and Video Conferences with Minimal Control
IETF RFC 4867	RTP Payload Format and Files Storage Format for the Adaptive Multi-Rate (AMR) and Adaptive Multi-Rate Wideband (AMR-WB) Audio Codecs
IETF RFC 5993	RTP Payload Format for Global Systems for Mobile Communications Half Rate (GSM-HR)

2 Overview

The OsmoBTS A-bis interface consists of traffic management messages (RSL, Radio Signalling Link) and network management messages (OML, Operation & Maintenance Link), encapsulated in an IPA multiplex.

OML and RSL each use a separate TCP connection.

Table 3: TCP port numbers used by OsmoBTS Abis/IP

TCP Port Number	Usage
3002	A-bis OML (inside IPA multiplex)
3003	A-bis RSL (inside IPA multiplex)

Both TCP connections for OML and RSL are established in the BTS → BSC direction, i.e. the BTS is running as a TCP client, while the BSC is running as a TCP server.

The BTS first establishes the TCP connection for OML. Via OML, the BSC instructs the BTS to which IP address the RSL connection shall be established.

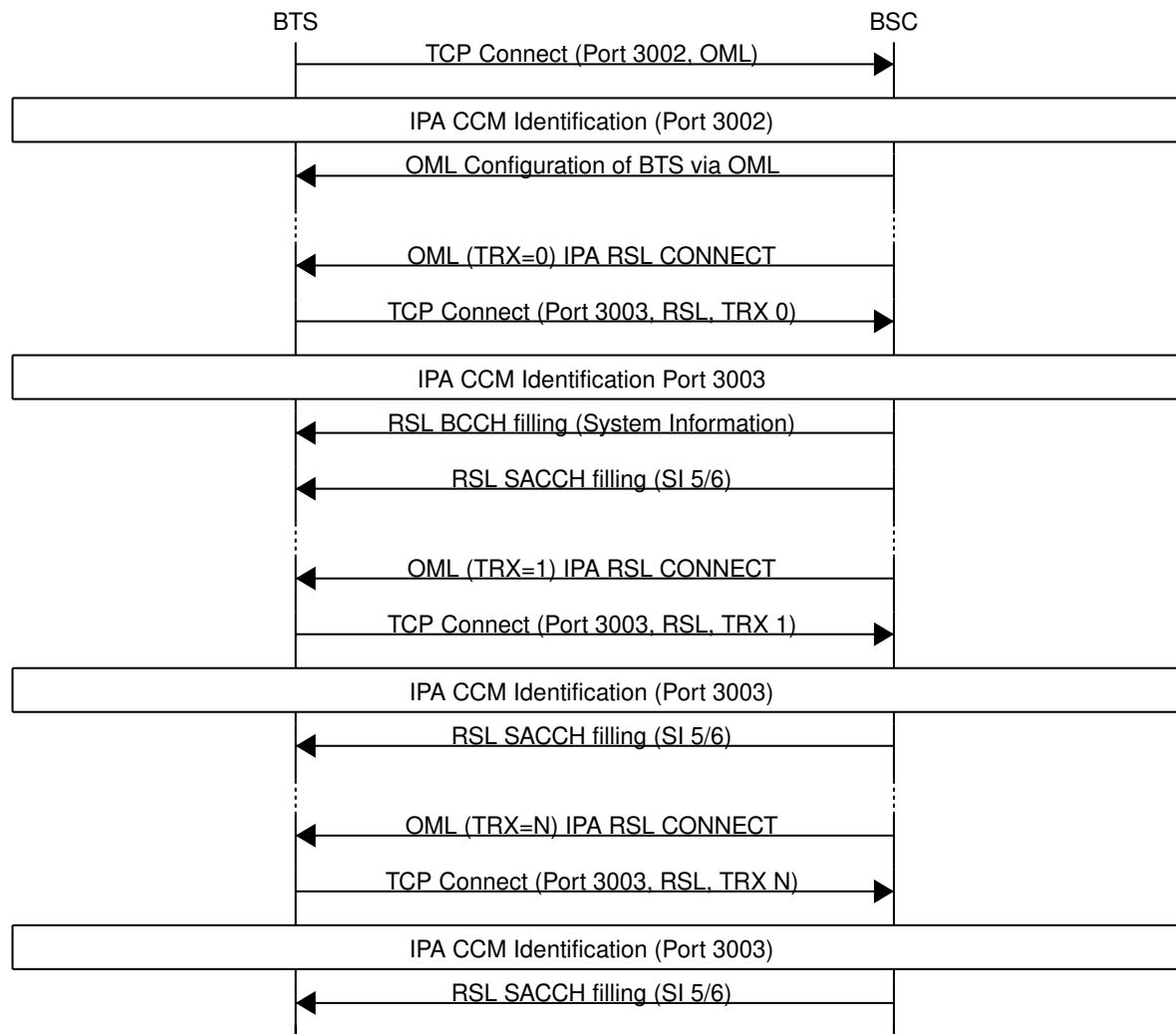

Figure 1: Overview of A-bis connection establishment

2.1 Identities

The BTS is locally configured (via administrative means, out of band of this specification) to have a Unit ID. The Unit ID consists of three parts:

- The Site Number
- The BTS number at the site
- The TRX number within the BTS

3 IPA Multiplex

The ETSI/3GPP specifications for A-bis transport (ETSI/3GPP TS 08.56) specify the transmission of RSL and OML messages over a LAPD based framing on top of 64kBit/s signalling times slots (B-channels) on E1 lines.

OsmoBTS does not implement this LAPD based transport, but instead implements A-bis over IP in a flavor first observed by ip.access nanoBTS products. The OsmoBTS implementation is a clean-room re-implementation based on the observation and dissection of protocol traces.

LAPD as used in E1 signalling channels provides in-order transmission and reliable delivery. This is why TCP was chosen as Layer 4 transport protocol on top of IP. TCP however, is a stream based transport protocol, which doesn't preserve the boundaries of messages.

To work around this shortcoming, an additional framing layer called the IPA multiplex was introduced between TCP and the RSL and OML messages.

Table 4: Protocol Stacking

RSL + OML (this document)
IPA (this document)
TCP (IETF RFC 793)
IP (IETF RFC 791)
Ethernet (IEEE 802.3)

3.1 IPA Header

Each higher-layer PDU is encapsulated by a three-byte IPA header with the following structure:

Table 5: IPA Header Structure

Offset (Octets)	Length	Name	Description
0	2	Length	Length of the variable-length payload section in network byte order (excluding the length of the IPA Header)
2	1	Stream Identifier	Identifies the stream of the payload
3	Variable	Payload	higher-layer PDU (i.e. RSL or OML message)

3.2 IPA Stream Identifiers

The IPA Stream Identifier serves to differentiate different streams within the multiplex. In the context of A-bis, it can be seen as analogous to the LAPD TEI on classic A-bis over E1.

The following IPA stream identifiers are being used in A-bis/IP:

Table 6: IPA Stream Identifiers

Value (Hex)	Name	Description
0x00	RSL	A-bis RSL according to this document, TRX 0
0x01	RSL	A-bis RSL according to this document, TRX 1
0x0n	RSL	A-bis RSL according to this document, TRX n
0xfe	CCM	IPA Connection Management
0xff	OML	A-bis OML according to this document

3.3 IPA Connection Management (CCM)

The IPA Connection Management is a sub-layer underneath the IPA multiplex which is used to manage the connection itself. It supports functions like Identity Management and Keep-Alive.

3.3.1 Identity Management

When a BTS connects to the BSC, the BSC must identify the connected BTS somehow. In ETSI/3GPP A-bis, the E1 multiplex + signalling timeslot number is used for this. In IP, there is no similar usable identity. Hence, the Unit ID is used for this purpose.

Table 7: Procedure for IPA peer identification is as follows

Direction	Operation
BTS → BSC	BTS connects the TCP connection to be used with IPA
BTS ← BSC	BSC requests BTS identity with ID_GET
BTS → BSC	BTS responds BTS Unit ID with ID_RESP
BTS ← BSC	BSC responds with ID_ACK, if the Unit ID is known to the BSC

Following the above peer identification procedure, transfer of higher-level messages such as OML or RSL commences.

3.3.2 IPA CCM Messages

IPA CCM supports the following messages

Table 8: IPA CCM Messages

Value	Name	Purpose
0x00	PING	Request a PONG from the peer
0x01	PONG	Response to a PING
0x04	ID_GET	Request Identity from peer
0x05	ID_RESP	Response to ID_GET
0x06	ID_ACK	Identity Acknowledged

4 Organization & Maintenance Link (OML)

4.1 List of Messages

The following tables list the OML messages used by OsmoBTS, grouped by their level of compliance with 3GPP TS 52.021 (previously 3GPP TS 12.21).

4.1.1 Messages Compliant With TS 52.021

Specific limitations apply, see the linked sections.

Table 9: Messages compliant with TS 52.021

TS 52.021 §	type code (hex)	This document §	Message	←/→	Received/Sent by OsmoBTS
SW Download Management Messages:					
8.3.7	0x10	Section 4.2.1	SW Activated Report	→	Sent
Air Interface Management Messages:					

Table 9: (continued)

TS 52.021 §	type code (hex)	This document §	Message	←/→	Received/Sent by OsmoBTS
8.6.1	0x41	Section 4.2.2	Set BTS Attributes	←	Received
	0x42		Set BTS Attributes Ack	→	Sent
	0x43		Set BTS Attributes Nack	→	Sent
8.6.2	0x44	Section 4.2.3	Set Radio Carrier Attributes	←	Received
	0x45		Set Radio Carrier Attributes Ack	→	Sent
	0x46		Set Radio Carrier Attributes Nack	→	Sent
8.6.3	0x47	Section 4.2.4	Set Channel Attributes	←	Received
	0x48		Set Channel Attributes Ack	→	Sent
	0x49		Set Channel Attributes Nack	→	Sent
State Management and Event Report Messages:					
8.8.1	0x61	Section 4.2.5	State Changed Event Report	→	Sent
8.8.5	0x69	Section 4.2.6	Change Administrative State	←	Received
	0x6A		Change Administrative State Ack	→	Sent
	0x6B		Change Administrative State Nack	→	Sent
Equipment Management Messages:					
8.9.2	0x74	Section 4.2.7	Opstart	←	Received
	0x75		Opstart Ack	→	Sent
	0x76		Opstart Nack	→	Sent
Other Messages:					
8.11.1	0x81	Section 4.2.8	Get Attributes	←	Received
	8.11.3	0x82	Section 4.2.9	Get Attribute Response	→
	Sent	8.11.1	0x83		Get Attributes Nack

4.1.2 Messages Specific to OsmoBTS

Table 10: Messages specific to OsmoBTS, not found in 3GPP TS 52.021

This document §	Message	←/→	Received/Sent by OsmoBTS
Section 4.3.1	Set Attribute	←	Received

4.1.3 Messages Not Implemented by OsmoBTS

Table 11: 3GPP TS 52.021 messages not implemented by OsmoBTS

TS 52.021 §	type code (hex)	Message
SW Download Management Messages:		
8.3.1	0x01	Load Data Initiate
	0x02	Load Data Initiate Ack
	0x03	Load Data Initiate Nack

Table 11: (continued)

TS 52.021 §	type code (hex)	Message
8.3.2	0x04	Load Data Segment
	0x05	Load Data Segment Ack
8.3.3	0x06	Load Data Abort
8.3.4	0x07	Load Data End
	0x08	Load Data End Ack
	0x09	Load Data End Nack
8.3.5	0x0A	SW Activate Request
	0x0B	SW Activate Request Ack
	0x0C	SW Activate Request Nack
8.3.6	0x0D	Activate SW
	0x0E	Activate SW Ack
	0x0F	Activate SW Nack
A-bis Interface Management Messages:		
8.4.1	0x21	Establish TEI
	0x22	Establish TEI Ack
	0x23	Establish TEI Nack
8.4.2	0x24	Connect Terrestrial Signalling
	0x25	Connect Terrestrial Signalling Ack
	0x26	Connect Terrestrial Signalling Nack
8.4.3	0x27	Disconnect Terrestrial Signalling
	0x28	Disconnect Terrestrial Signalling Ack
	0x29	Disconnect Terrestrial Signalling Nack
8.4.4	0x2A	Connect Terrestrial Traffic
	0x2B	Connect Terrestrial Traffic Ack
	0x2C	Connect Terrestrial Traffic Nack
8.4.5	0x2D	Disconnect Terrestrial Traffic
	0x2E	Disconnect Terrestrial Traffic Ack
	0x2F	Disconnect Terrestrial Traffic Nack
Transmission Management Messages:		
8.5.1	0x31	Connect Multi-Drop Link
	0x32	Connect Multi-Drop Link Ack
	0x33	Connect Multi-Drop Link Nack
8.5.2	0x34	Disconnect Multi-Drop Link
	0x35	Disconnect Multi-Drop Link Ack
	0x36	Disconnect Multi-Drop Link Nack
Test Management Messages:		
8.7.1	0x51	Perform Test
	0x52	Perform Test Ack
	0x53	Perform Test Nack
8.7.2	0x54	Test Report
	0x55	Send Test Report
	0x56	Send Test Report Ack
8.7.3	0x57	Send Test Report Nack
8.7.4	0x58	Stop Test
	0x59	Stop Test Ack
	0x5A	Stop Test Nack
State Management and Event Report Messages:		
8.8.2	0x62	Failure Event Report
8.8.3	0x63	Stop Sending Event Reports
	0x64	Stop Sending Event Reports Ack
	0x65	Stop Sending Event Reports Nack
8.8.4	0x66	Restart Sending Event Reports
	0x67	Restart Sending Event Reports Ack

Table 11: (continued)

TS 52.021 §	type code (hex)	Message
	0x68	Restart Sending Event Reports Nack
8.8.6	0x6C	Change Administrative State Request
	0x6D	Change Administrative State Request Ack
	0x6E	Change Administrative State Request Nack
8.8.7	0x93	Report Outstanding Alarms
	0x94	Report Outstanding Alarms Ack
	0x95	Report Outstanding Alarms Nack
Equipment Management Messages:		
8.9.1	0x71	Changeover
	0x72	Changeover Ack
	0x73	Changeover Nack
8.9.3	0x87	Reinitialize
	0x88	Reinitialize Ack
	0x89	Reinitialize Nack
8.9.4	0x77	Set Site Outputs
	0x78	Set Site Outputs Ack
	0x79	Set Site Outputs Nack
8.9.5	0x90	Change HW Configuration
	0x91	Change HW Configuration Ack
	0x92	Change HW Configuration Nack
Measurement Management Messages:		
8.10.1	0x8A	Measurement Result Request
8.10.2	0x8B	Measurement Result Response
8.10.3	0x8C	Stop Measurement
8.10.4	0x8D	Start Measurement
Other Messages:		
8.11.2	0x84	Set Alarm Threshold
	0x85	Set Alarm Threshold Ack
	0x86	Set Alarm Threshold Nack

4.2 Details on Compliant OML Messages

4.2.1 SW Activated Report

OsmoBTS will send an *SW Activated Report* when RF has been activated successfully. The message is compliant with 3GPP TS 52.021 § 8.3.7.

Upon RF activation, two *SW Activated Report* messages will be sent, for the Object Classes

- Radio Carrier (0x02)
- Baseband Transceiver (0x04)

4.2.2 Set BTS Attributes

OsmoBTS will receive a *Set BTS Attributes* message and reply with a corresponding ACK message on success. IE handling is fully compliant to TS 52.021, except that a change of BCCH ARFCN or BSIC while in operation is not supported, and hence the *Starting Time* IE is rejected.

Table 12: *Set BTS Attributes* IEs not handled by OsmoBTS

TS 52.021 §	IE Name	Handling
9.4.52	Starting Time	not supported (provokes NACK cause 0x10)

4.2.3 Set Radio Carrier Attributes

This message conforms to 3GPP TS 52.021, with the following limitation, as frequency hopping is not supported by OsmoBTS:

Table 13: *Set Radio Carrier Attributes* IE limitations

TS 52.021 §	IE Name	Handling
9.4.5	ARFCN List	ignored

4.2.4 Set Channel Attributes

This message conforms to 3GPP TS 52.021, with the following limitation: the following 3GPP TS 52.021 IEs provoke a NACK response when sent to OsmoBTS, as frequency hopping is not supported:

Table 14: *Set Channel Attributes* IE limitations

TS 52.021 §	IE Name	Handling
9.4.21	HSN	not supported (provokes NACK cause 0x10)
9.4.27	MAIO	not supported (provokes NACK cause 0x10)
9.4.52	Starting Time	not supported (provokes NACK cause 0x10)

4.2.5 State Changed Event Report

This message is compliant with 3GPP TS 52.021. Exactly these IEs are sent by OsmoBTS:

INFORMATION ELEMENT	REFERENCE	PRESENCE	FORMAT	LENGTH
Message Type (0xf5)	3GPP TS 52.021 9.1	M	V	1
Object Class	3GPP TS 52.021 9.2	M	V	1
Object Instance	3GPP TS 52.021 9.3	M	V	3
Operational State	3GPP TS 52.021 9.4.38	O	TV	2
Availability Status	3GPP TS 52.021 9.4.7	O	TL16V (with length of 1)	3

4.2.6 Change Administrative State

This message is compliant with 3GPP TS 52.021 § 8.8.5. It applies to all of the Object Classes defined in 3GPP TS 52.021 § 9.2 as well as Section 4.4.

4.2.7 Opstart

This message is compliant with 3GPP TS 52.021 § 8.9.2. It applies to all of the Object Classes defined in 3GPP TS 52.021 § 9.2 as well as Section 4.4.

4.2.8 Get Attributes

This message is compliant with 3GPP TS 52.021 § 8.11.1.

For a list of supported attributes, see Section 4.2.9.

4.2.9 Get Attribute Response

This message is compliant with 3GPP TS 52.021 § 8.11.3.

The following attributes are provided by OsmoBTS:

3GPP TS 52.021 chapter	description	see
9.4.61	SW Configuration	Section 4.6.21
9.4.30	Manufacturer Id	Section 4.6.22

4.3 Details on OsmoBTS Specific Messages

4.3.1 Set Attribute

The message type is 0xf5. This message is sent to OsmoBTS to set attributes on instances of managed objects of the non-standard additional Object Classes (see Section 4.4).

The message specifics depend on the Object Class and are detailed in Section 4.4.

INFORMATION ELEMENT	REFERENCE	PRESENCE	FORMAT	LENGTH
Message Type (0xf5)	3GPP TS 52.021 9.1	M	V	1
Object Class	3GPP TS 52.021 9.2	M	V	1
Object Instance	3GPP TS 52.021 9.3	M	V	3
<i>Object Class specific IEs follow, see Section 4.4...</i>				

4.4 Additional Object Classes

In addition to 3GPP TS 52.021 Chapter 9.2, the following managed objects are supported:

Table 15: Additional Managed Object Classes

Value	Name	Description
0xf0	GPRS NSE	GPRS-NS Entity
0xf1	GPRS CELL	GPRS Cell Entity
0xf2	GPRS NSVC	GPRS NS Virtual Circuit

4.4.1 GPRS-NSE Managed Object

There is one NS Entity per BTS. It supports the **Set Attribute** message with the following Information Elements:

INFORMATION ELEMENT	REFERENCE	PRESENCE	FORMAT	LENGTH
Message Type	3GPP TS 52.021 9.1	M	V	1
Object Class	3GPP TS 52.021 9.2	M	V	1
Object Instance	3GPP TS 52.021 9.3	M	V	3
GPRS NSEI	Section 4.6.11	O	TL16V	>= 5
GPRS NS Configuration	Section 4.6.16	O	TL16V	>= 10
GPRS BSSGP Configuration	Section 4.6.15	O	TL16V	>= 14

4.4.2 GPRS Cell Managed Object

There is one GPRS Cell entity per BTS. It supports the **Set Attribute** message with the following Information Elements:

INFORMATION ELEMENT	REFERENCE	PRESENCE	FORMAT	LENGTH
Message Type	3GPP TS 52.021 9.1	M	V	1
Object Class	3GPP TS 52.021 9.2	M	V	1
Object Instance	3GPP TS 52.021 9.3	M	V	3
GPRS Routing Area Code	Section 4.6.9	O	TL16V	>= 4
GPRS Paging Configuration	Section 4.6.10	O	TL16V	>= 5
GPRS RLC Configuration	Section 4.6.17	O	TL16V	>= 12
GPRS Coding Schemes	Section 4.6.18	O	TL16V	>= 5
GPRS RLC Configuration 2	Section 4.6.19	O	TL16V	>= 8
GPRS RLC Configuration 3	Section 4.6.20	O	TL16V	>= 4

4.4.3 GPRS NS-VC Managed Object

There are two GPRS NS-VC instances per BTS. It supports the **Set Attribute** message with the following Information Elements:

INFORMATION ELEMENT	REFERENCE	PRESENCE	FORMAT	LENGTH
Message Type	3GPP TS 52.021 9.1	M	V	1
Object Class	3GPP TS 52.021 9.2	M	V	1
Object Instance	3GPP TS 52.021 9.3	M	V	3
GPRS NSVCI	Section 4.6.13	O	TL16V	>= 5
GPRS NS Link Configuration	Section 4.6.16	O	TL16V	>= 11

4.5 Information Elements Overview

All of the IEs handled by OsmoBTS are listed below, with limitations and additions to TS 52.021 specified in more detail.

4.5.1 IEs Conforming to TS 52.021

The following Information Elements are accepted by OsmoBTS.

IEs marked *ignored* may be sent to OsmoBTS without causing error conditions. These IEs are skipped during message parsing and are never evaluated.

IEs marked *ignored* and additionally marked as being received by OsmoBTS (←) are in fact parsed and their values are stored by OsmoBTS, but these stored items are currently not used in the OsmoBTS code base.

Table 16: IEs conforming to TS 52.021

tag (hex)	TS 52.021 §	IE name	←/→	Received/Sent by OsmoBTS
0x00	9.4.1	Abis Channel		<i>ignored</i>
0x01	9.4.2	Additional Info		<i>ignored</i>
0x02	9.4.3	Additional Text		<i>ignored</i>
0x03	9.4.4	Administrative State	← →	Received & Sent
0x04	9.4.5	ARFCN List	←	Received, with exactly 1 ARFCN: see Section 4.6.2; ignored by <i>Set Radio Attribute</i> message (Section 4.2.3)
0x05	9.4.6	Autonomously Report		<i>ignored</i>
0x06	9.4.7	Availability Status	→	Sent
0x07	9.4.8	BCCH ARFCN	←	Received
0x08	9.4.9	BSIC	←	Received
0x09	9.4.10	BTS Air Timer	←	Received
0x0a	9.4.11	CCCH Load Indication Period	←	Received
0x0b	9.4.12	CCCH Load Threshold	←	Received
0x0c	9.4.13	Channel Combination	←	Received, with additional channel combinations: see Section 4.6.3
0x0d	9.4.14	Connection Failure Criterion	←	Received, with limitations see Section 4.6.4
0x0e	9.4.15	Destination		<i>ignored</i>
0x0f	9.4.16	Event Type		<i>ignored</i>
0x11	9.4.17	File Data		<i>ignored</i>
0x12	9.4.18	File Id		<i>ignored</i>
0x13	9.4.19	File Version		<i>ignored</i>
0x14	9.4.20	GSM Time		<i>ignored</i>
0x16	9.4.22	HW Configuration		<i>ignored</i>
0x18	9.4.24	Intave Parameter	←	
0x19	9.4.25	Interference level Boundaries	←	
0x1a	9.4.26	List of Required Attributes		<i>ignored</i>
0x1c	9.4.28	Manufacturer Dependent State		<i>ignored</i>
0x1d	9.4.29	Manufacturer Dependent Thresholds		<i>ignored</i>
0x1e	9.4.30	Manufacturer Id		<i>ignored</i>
0x1f	9.4.31	Max Timing Advance	←	Received
0x20	9.4.34	Multi-drop BSC Link		<i>ignored</i>
0x21	9.4.35	Multi-drop next BTS Link		<i>ignored</i>
0x22	9.4.36	Nack Causes	→	Sent
0x23	9.4.37	Nyl	←	Received
0x24	9.4.38	Operational State	→	Sent
0x25	9.4.39	Overload Period	←	<i>ignored</i>
0x26	9.4.40	Physical Config		<i>ignored</i>
0x27	9.4.41	Power Class		<i>ignored</i>
0x28	9.4.42	Power Output Thresholds		<i>ignored</i>
0x29	9.4.43	Probable Cause		<i>ignored</i>
0x2a	9.4.44	RACH Busy Threshold	←	Received
0x2b	9.4.45	RACH Load Averaging Slots	←	<i>ignored</i>
0x2c	9.4.46	Radio Sub Channel		<i>ignored</i>
0x2d	9.4.47	RF Max Power Reduction	←	Received
0x2e	9.4.48	Site Inputs		<i>ignored</i>
0x2f	9.4.49	Site Outputs		<i>ignored</i>
0x30	9.4.50	Source		<i>ignored</i>
0x31	9.4.51	Specific Problems		<i>ignored</i>
0x33	9.4.53	T200	←	<i>ignored</i> (1s on DCCH, 2s on ACCH)
0x34	9.4.54	TEI		<i>ignored</i>
0x35	9.4.55	Test Duration		<i>ignored</i>

Table 16: (continued)

tag (hex)	TS 52.021 §	IE name	←/→	Received/Sent by OsmoBTS
0x36	9.4.56	Test No		<i>ignored</i>
0x37	9.4.57	Test Report Info		<i>ignored</i>
0x38	9.4.58	VSWR Thresholds		<i>ignored</i>
0x39	9.4.59	Window Size		<i>ignored</i>
0x40	9.4.60	TSC	←	Received, with limitations: see Section 4.6.5
0x41	9.4.61	SW Configuration	→	Sent, see Section 4.6.21
0x43	9.4.63	Perceived Severity		<i>ignored</i>
0x44	9.4.64	Get Attribute Response Info	→	Sent, see Section 4.6.22
0x45	9.4.65	Outstanding Alarm Sequence		<i>ignored</i>
0x46	9.4.66	HW Conf Change Info		<i>ignored</i>
0x47	9.4.32	Measurement Result		<i>ignored</i>

4.5.2 IEs Not Conforming to TS 52.021

Table 17: IEs not conforming to TS 52.021

tag (hex)	TS 52.021 §	IE name	Description
0x15	9.4.21	HSN	presence causes NACK response
0x17	9.4.23	HW Description	<i>ignored</i> by OsmoBTS, but coding may differ, see Section 4.6.1
0x1b	9.4.27	MAIO	presence causes NACK response
0x32	9.4.52	Starting Time	presence causes NACK response
0x42	9.4.62	SW Description	not supported
0x48	9.4.33	Measurement Type	not supported

4.5.3 Additional Attributes and Parameters

The following Information Elements are defined in addition to those specified in 3GPP TS 52.021 Chapter 9.4.

All of these additional IEs are *received* by OsmoBTS.

These attributes are not used by OsmoBTS, but simply passed to OsmoPCU connected to the PCU socket.

Table 18: Additional IEs handled by OsmoBTS but not defined in TS 52.021

tag (hex)	IE name	Description
0x80	RSL Destination IP Address	Section 4.6.6
0x81	RSL Destination TCP Port	Section 4.6.7
0x85	RSL IPA Stream ID	Section 4.6.8
0x9a	GPRS Routing Area Code	Section 4.6.9
0x9c	GPRS Paging Configuration	Section 4.6.10
0x9d	GPRS NSEI	Section 4.6.11

Table 18: (continued)

tag (hex)	IE name	Description
0x9e	GPRS BVCI	Section 4.6.12
0x9f	GPRS NSVCI	Section 4.6.13
0xa0	GPRS NS Configuration	Section 4.6.14
0xa1	GPRS BSSGP Configuration	Section 4.6.15
0xa2	GPRS NS Link Configuration	Section 4.6.16
0xa3	GPRS RLC Configuration	Section 4.6.17
0xa8	GPRS Coding Schemes	Section 4.6.18
0xa9	GPRS RLC Configuration 2	Section 4.6.19
0xac	GPRS RLC Configuration 3	Section 4.6.20

4.6 Details on IEs

4.6.1 HW Description

TS 52.021 suggests a series of 5 length-value pairs for the *HW Description* IE. Instead, OsmoBTS interprets it as a single TL16V. The value of this IE is ignored by OsmoBTS, yet the coding may affect message parsing.

Attribute Identifier (0x17)	1
Length	2-3
Ignored	N

4.6.2 ARFCN List

Since OsmoBTS does not support frequency hopping, the *ARFCN List* must contain exactly one ARFCN.

4.6.3 Additional Channel Combinations

In addition to 3GPP TS 52.021 Chapter 9.4.13, the following channel combinations are supported:

Table 19: Additional Channel Combinations

Value	Description
0x0b	Reserved for PBCCH + PCCCH + PDTCH/F + PACCH/F + PTCCH/F
0x0c	Reserved for PBCCH + PDTCH/F + PACCH/F + PTCCH/F
0x0d	PDTCH/F + PACCH/F + PTCCH/F
0x80	ip.access style Dynamic TCH/F / PDCH
0x81	Reserved for Dynamic TCH/F / TCH/H
0x90	Osmocom style Dynamic TCH/F / TCH/H / PDCH

The *Reserved* combinations are not actually supported/implemented yet, but merely reserved for such functionality, if it is eventually implemented.

For more information on how the different dynamic channel combinations work, please see the Section 5.4.

4.6.4 Connection Failure Criterion

3GPP TS 52.021 Chapter 9.4.14 specifies two different options for the *Connection Failure Criterion*. OsmoBTS only implements the option coded as 0x01, i.e. based upon uplink SACCH error rate (RADIO_LINK_TIMEOUT).

4.6.5 TSC

Due to limitations in the currently supported PHY implementations, OsmoBTS supports only one global TSC for all channels on one TRX, rather than a separate TSC for each timeslot, as expected by 3GPP TS 52.021.

4.6.6 RSL Destination IP Address

The value part of this attribute has a length of 4 octets and is encoded as IPv4 address in network byte order.

Attribute Identifier (0x80)	1
IPv4 Address (MSB first)	2-5

4.6.7 RSL Destination TCP Port

The value part of this attribute has a length of 2 octets and contains the TCP destination port for the RSL connection, encoded in network byte order.

Attribute Identifier (0x81)	1
Port number (MSB first)	2-3

4.6.8 RSL IPA Stream ID

The value part of this attribute has a length of one octet and specifies the IPA stream ID to be used for the RSL connection of this TRX.

Attribute Identifier (0x85)	1
Stream ID	2

4.6.9 GPRS Routing Area Code

The value part of the GPRS Routing Area code consists of a single octet encoding the GPRS Routing Area Code.

This attribute is not used by OsmoBTS, but simply passed to OsmoPCU connected to the PCU socket.

4.6.10 GPRS Paging Configuration

The value part of this attribute consists of two octets encoded as follows:

Offset	Description
0	GPRS Paging repeat time in units of 50ms intervals
1	GPRS Paging repeat count

4.6.11 GPRS NSEI

The value part of the GPRS NSEI is encoded as 16bit integer value in network byte order.

This attribute is not used by OsmoBTS, but simply passed to OsmoPCU connected to the PCU socket.

4.6.12 GPRS BVCI

The value part of this attribute consists of two octets encoding the BSSGP Virtual Circuit Identifier (BVCI) as unsigned 16 bit integer in network byte order.

4.6.13 GPRS NSVCI

The value part of the GPRS NSVCI attribute is a 16bit unsigned integer in network byte order, encoding the GPRS NSVCI as specified in 3GPP TS 08.16.

This attribute is not used by OsmoBTS, but simply passed to OsmoPCU connected to the PCU socket.

4.6.14 GPRS NS Configuration

The value part of the GPRS NS Configuration consists of an array of 7 octets, each describing one GPRS NS related timer:

This attribute is not used by OsmoBTS, but simply passed to OsmoPCU connected to the PCU socket.

4.6.15 GPRS BSSGP Configuration

The value part of the GPRS BSSGP configuration consists of an array of 11 octets, each describing one GPRS BSSGP related timer:

Offset	Description
0	Blocking Timer (T1)
1	Blocking Retries
2	Unblocking Retries
3	Reset Timer (T2)
4	Reset Retries
5	Suspend Timer (T3) in units of 100ms
6	Suspend Retries
7	Resume Timer (T4) in units of 100ms
8	Resume Retries
9	Capability Update Timer (T5)
10	Capability Update Retries

The detailed description of the meaning of those timers is given in the GPRS BSSGP specification 3GPP TS 08.18.

This attribute is not used by OsmoBTS, but simply passed to OsmoPCU connected to the PCU socket.

4.6.16 GPRS NS Link Configuration

This attribute is 8 octets long and encoded as follows:

Offset	Length	Description
0	2	GPRS-NS Remote UDP Port Number (SGSN side)
2	4	GPRS-NS Remote IPv4 Address (SGSN side)
6	2	GPRS-NS Local UDP Port Number (BTS side)

All values are encoded in network byte order.

This attribute is not used by OsmoBTS, but simply passed to OsmoPCU connected to the PCU socket.

4.6.17 GPRS RLC Configuration

The value part of the GPRS RLC Configuration consists of an array of 9 octets, each describing a RLC timer:

Offset	Description	Unit
0	GPRS RLC Timer T3142	s
1	GPRS RLC Timer T3169	s
2	GPRS RLC Timer T3191	s
3	GPRS RLC Timer T3193	10ms
4	GPRS RLC Timer T3195	s
5	GPRS RLC Timer T3101	s
6	GPRS RLC Timer T3103	s
7	GPRS RLC Timer T3105	s
8	GPRS RLC CV Countdown	-

The meaning of the RLC timers are specified in 3GPP TS 04.60.

The countdown value specifies the RLC CV value from which the countdown procedure is started.

This attribute is not used by OsmoBTS, but simply passed to OsmoPCU connected to the PCU socket.

4.6.18 GPRS Coding Schemes

The value part of the GPRS Coding Schemes consists of two octets encoding the available GPRS and EDGE coding schemes.

bit	7	6	5	4	3	2	1	0
byte at offset 0	MCS9	x	x	x	CS4	CS3	CS2	CS1
byte at offset 1	MCS8	MCS7	MCS6	MCS5	MCS4	MCS3	MCS2	MCS1

This attribute is not used by OsmoBTS, but simply passed to OsmoPCU connected to the PCU socket.

4.6.19 GPRS RLC Configuration 2

The value part of this attribute is 8 octets long and encoded as follows:

Offset	Length	Description	Unit
0	2	Downlink TBF Extension Timer	10ms
2	2	Uplink TBF Extension Timer	10ms
4	2	Initial GPRS Coding Scheme	-

The Initial GPRS Coding Scheme is encoded as follows:

Value	Description
1	CS 1
2	CS 2
3	CS 3
4	CS 4

This attribute is not used by OsmoBTS, but simply passed to OsmoPCU connected to the PCU socket.

4.6.20 GPRS RLC Configuration 3

This attribute contains information about the initial MCS used for new EDGE TBFs.

It is encoded as follows:

Value	Description
1	MCS 1
2	MCS 2
3	MCS 3
4	MCS 4
5	MCS 5
6	MCS 6
7	MCS 7
8	MCS 8
9	MCS 9

This attribute is not used by OsmoBTS, but simply passed to OsmoPCU connected to the PCU socket.

4.6.21 SW Configuration

The SW Configuration IE is compliant with 3GPP TS 52.021 9.4.61: it contains a number of SW Description IEs (9.4.62).

Table 20: Coding of SW Configuration IE

octet	value
1	NM_ATT_SW_CONFIG IEI (0x41)
2-3	length of value part
4	NM_ATT_SW_DESCR IEI (0x42)
5	NM_ATT_FILE_ID IEI (0x12)
6-7	length of file name
8-N	ASCII coded file name (without terminating nul)
N+1	NM_ATT_FILE_VERSION IEI (0x13)
N+2 - N+3	length of file content
N+4 - M	file content
M+1	NM_ATT_SW_DESCR IEI (0x42)
M+2	NM_ATT_FILE_ID IEI (0x12)
...	

Table 21: File names and content sent in the SW Configuration IE

file name	content
<i>osmobts</i>	ASCII coded OsmoBTS version number like "1.2.3" or "1.2.3.4-abcd"
<i>BTS_TYPE_VARIANT</i>	one of "osmo-bts-lc15", "osmo-bts-oc2g", "osmo-bts-octphy", "osmo-bts-omldummy", "osmo-bts-sysmo", "osmo-bts-trx", "osmo-bts-virtual"
<i>BTS_SUB_MODEL</i>	This file may be omitted; if present, may contain an ASCII coded model number like "sysmoBTS 1002"

4.6.22 Manufacturer Id

The coding of the Manufacturer Id attribute is a sequence of bit flags (a bit vector), where a zero flag indicates absence and a set flag indicates presence of a specific BTS feature.

The number of flags transmitted depends on the software version of OsmoBTS and the BTS backend in use. More flags may be added in the future. The flag bits transmitted are followed by zero bits up to the next full octet boundary.

These features are currently defined:

Table 22: coding of BTS feature flags sent in the Manufacturer Id attribute

octet	bit	feature name	description
0	7	HSCSD	High-Speed Circuit-Switched Data
	6	GPRS	General Packet Radio Service
	5	EGPRS	Enhanced GPRS (EDGE)
	4	ECSD	Enhanced Circuit-Switched Data
	3	HOPPING	Frequency Hopping
	2	MULTI_TSC	Multi-TSC
	1	OML_ALERTS	OML Alerts
	0	AGCH_PCH_PROP	AGCH/PCH proportional allocation
1	7	CBCH	Cell Broadcast Channel
	6	SPEECH_F_V1	Fullrate speech V1
	5	SPEECH_H_V1	Halfrate speech V1
	4	SPEECH_F_EFR	Fullrate speech EFR
	3	SPEECH_F_AMR	Fullrate speech AMR
	2	SPEECH_H_AMR	Halfrate speech AMR
	1	ETWS_PN	ETWS Primary Notification via PCH
	0	PAGING_COORDINATION	BSS Paging Coordination
2	7	IPV6_NSVC	NSVC IPv6
	6	ACCH_REP	FACCH/SACCH Repetition
	5	CCN	Cell Change Notification
	4	VAMOS	Voice services over Adaptive Multi-user channels on One Slot
	3	reserved for future use, sent as zero	
	2		
	1		
	0		

4.7 A-bis OML Initialization / BTS bring-up

At the time an Abis/IP BTS connects to via OML to the BSC, it is initialized according to the procedures described in 3GPP TS 52.021 as amended by this document.

Each Managed Object (MO) is separately initialized. The initialization sequence and parameters differ slightly depending on the MO involved.

Some parts of the sequences described below are optional, such as the Software activation. In the OsmoBTS case, the software is not modular and thus all MOs start with the software fully activated. In effect, no *Software Activate Request* is being sent by the MO to the BSC, nor does the BSC need to initialize the *Activate Software* procedure.

Still, the full sequences are shown in order to explain the Abis/IP protocol.

Also, the initial state of the MOs at time of OML connection initialization is not always guaranteed to be *Disabled/Notinstalled*. Rather, the BSC implementation has to deal with the initial state as reported by the MOs at time of re-connection.

4.7.1 Site Manager MO Initialization

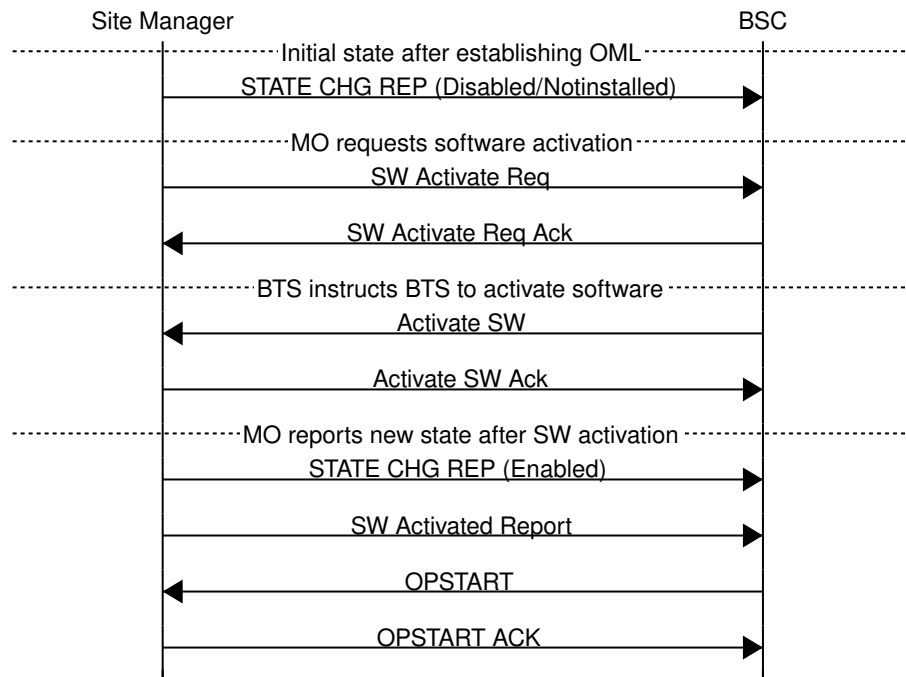

Figure 2: A-bis OML Initialization of Site Manager MO

The Site Manager MO does not depend on other MOs, nor does it have an Administrative state (*Locked/Unlocked*), thus it immediately commences in the *Enabled* state.

4.7.2 BTS MO Initialization

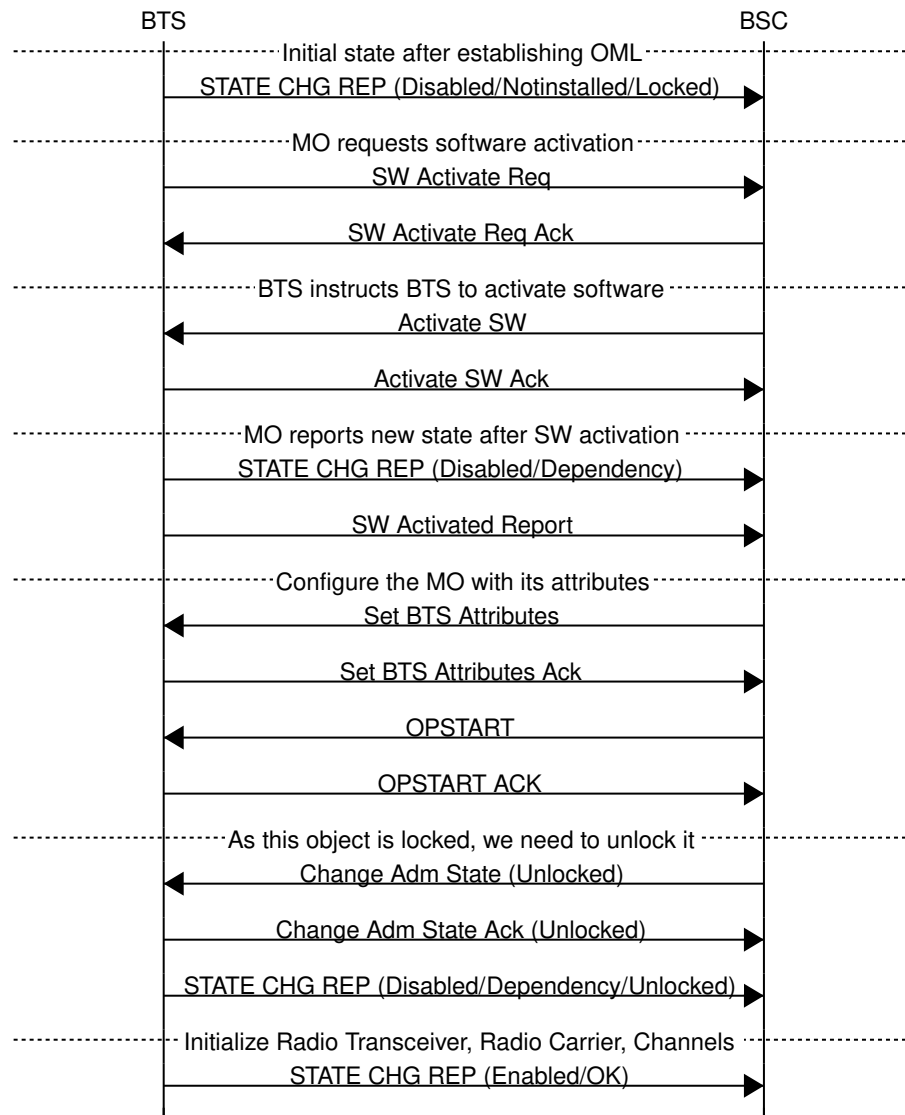

Figure 3: A-bis OML Initialization of BTS MO

As shown in the BTS MO, its state is

- Availability state *Dependency*, meaning it depends on other MOs to be initialized before becoming enabled.
- Administrative state *Locked*, as the object is first waiting to receive attributes in the *Locked* state, before the *Change Administrative State (Unlocked)* procedure is used to request transitioning into Unlocked state.

4.7.3 Baseband Transceiver MO Initialization

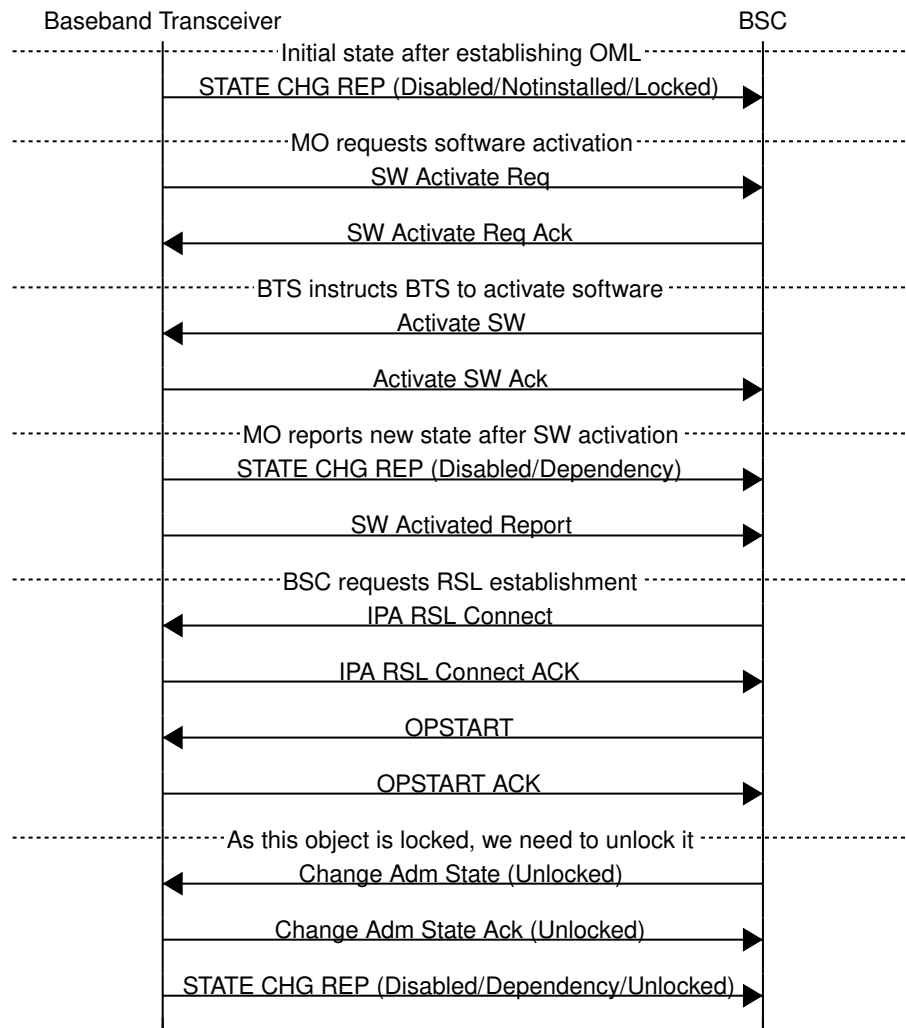

Figure 4: A-bis OML Initialization of Baseband Transceiver MO

There is one Baseband Transceiver MO per TRX in the BTS. For a multi-TRX BTS, the above procedure must be repeated for each TRX.

4.7.4 Radio Carrier MO Initialization

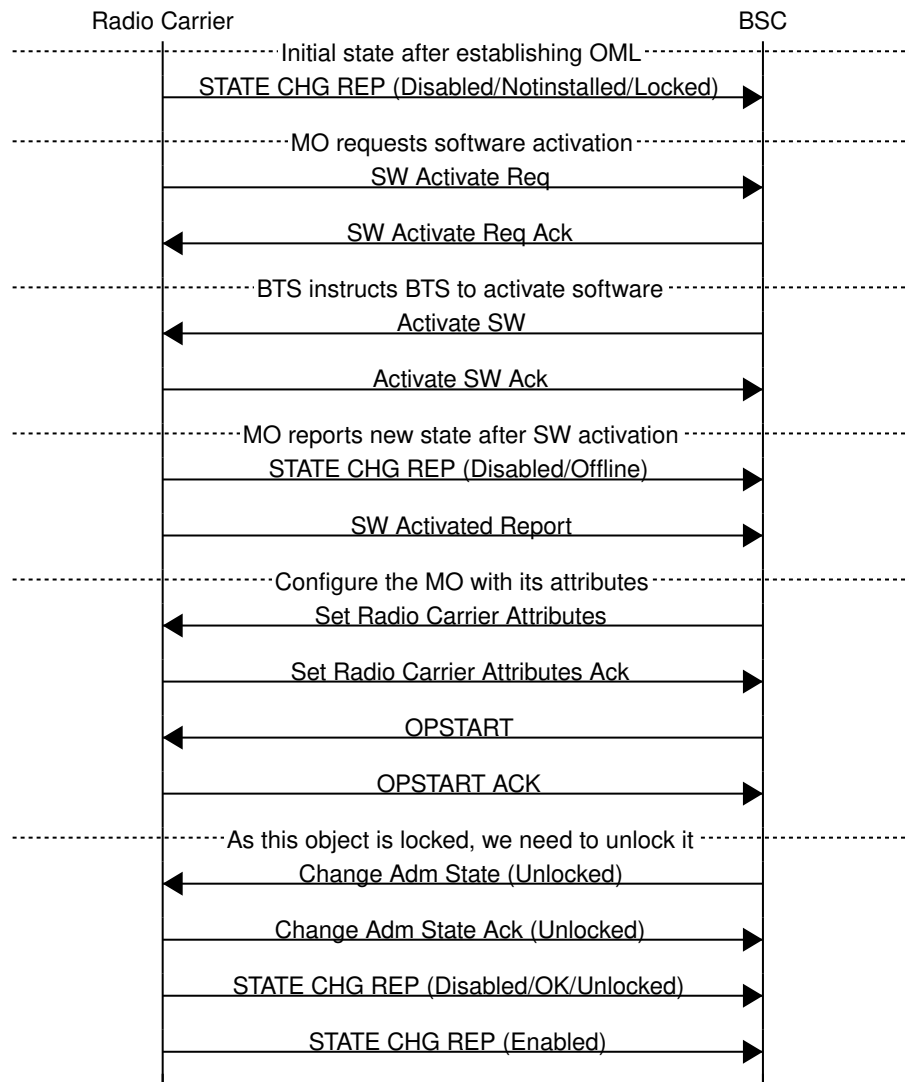

Figure 5: A-bis OML Initialization of Radio Carrier MO

There is one Radio Carrier MO per TRX in the BTS. For a multi-TRX BTS, the above procedure must be repeated for each TRX.

4.7.5 Channel MO Initialization

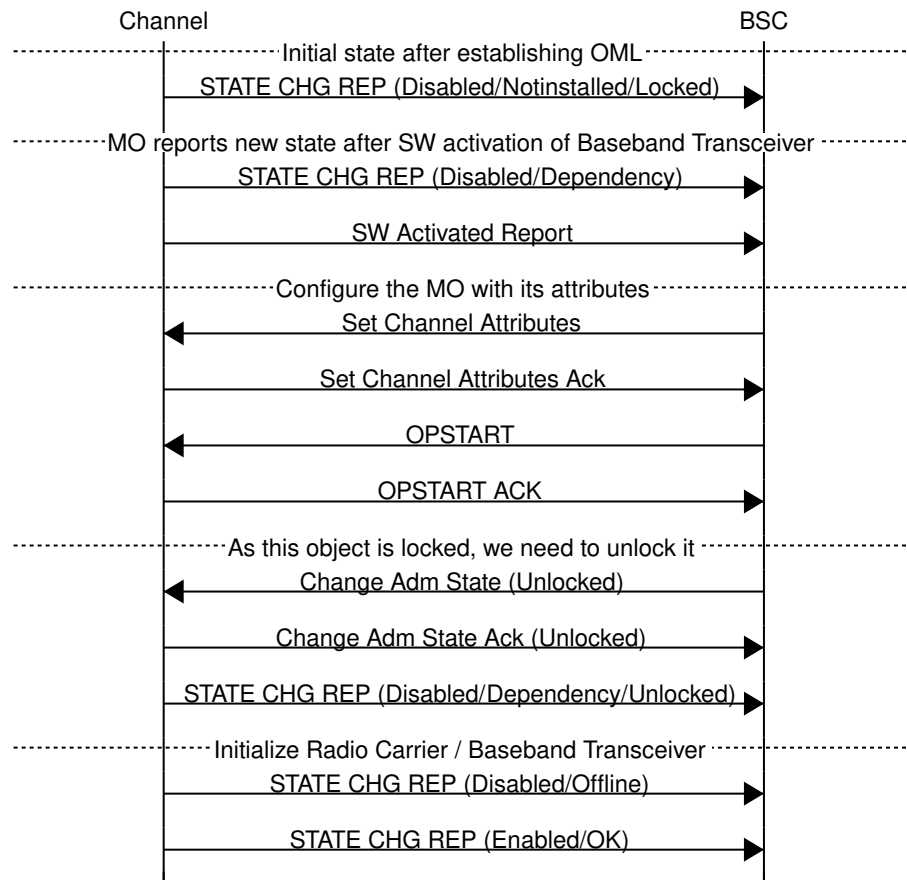

Figure 6: A-bis OML Initialization of Radio Carrier MO

There are 8 timeslots in each TRX, and correspondingly 8 Channel MOs in every TRX. The above procedure must thus be repeated for each timeslot in each transceiver of the BTS.

4.7.6 Complete BTS Initialization Procedure

Some of below steps are optional, as is their detailed ordering. In practice, the procedures for different MOs may overlap. The message sequence charts in this document have been hand-crafted to avoid such overlap for the sake of clarity.

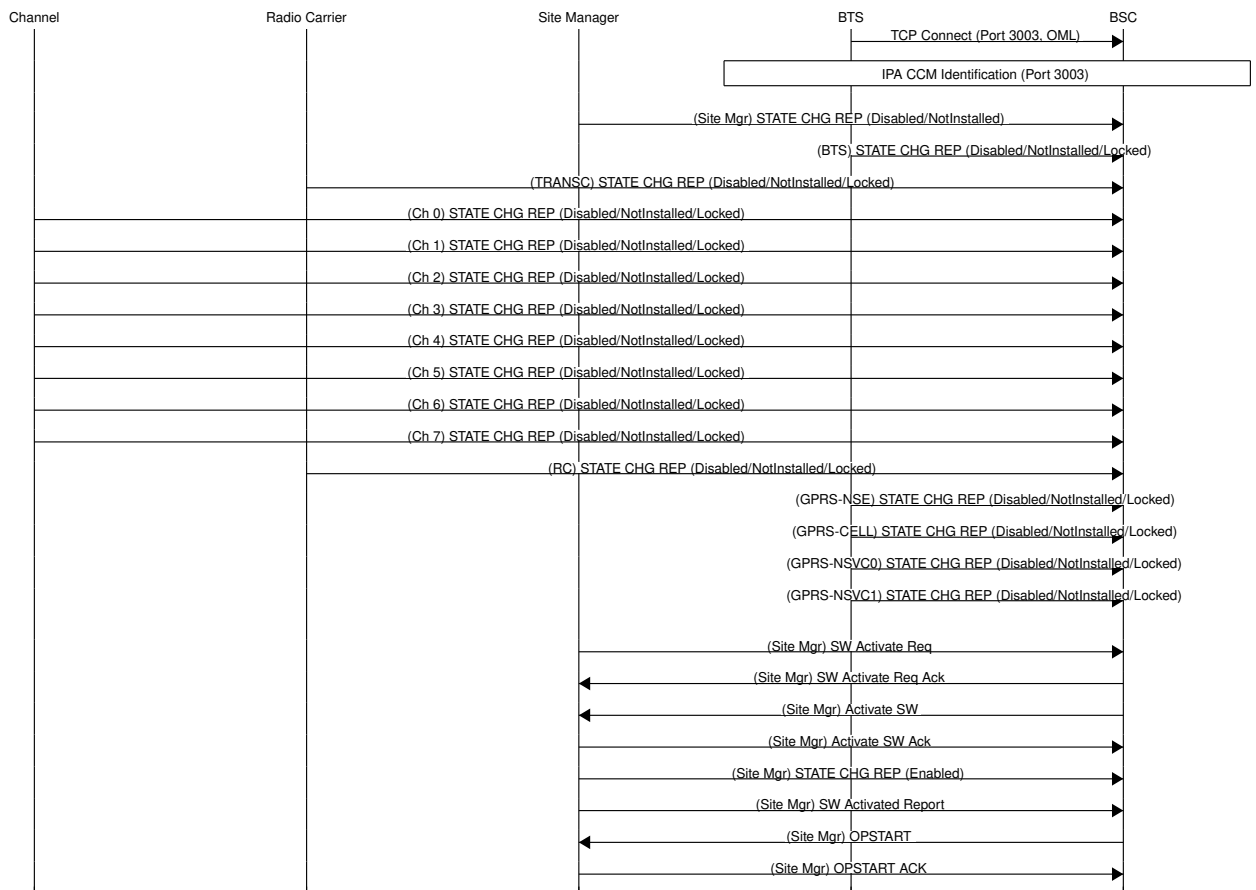

Figure 7: A-bis OML BTS bring-up (1/3)

As shown in Figure 7, after the OML TCP connection is established,

1. the identity is exchanged via IPA CCM,
2. the BTS sends an *OML EVENT STATE CHANGED REPORT* for every Managed Object, and
3. the BTS subsequently requests the activation of its *Site Manager* Object which the BSC performs by the *Activate SW* command.
4. After successful activation of the software in the Site Manager,
 - a. the state changes to *Enabled*, and an event report is generated accordingly, and
 - b. the BSC is notified about the SW activation in an associated report.
5. Finally, the BSC requests the start of the Site Manager
 - a. using the *OPSTART* command,
 - b. which is subsequently acknowledged by the Site Manager.

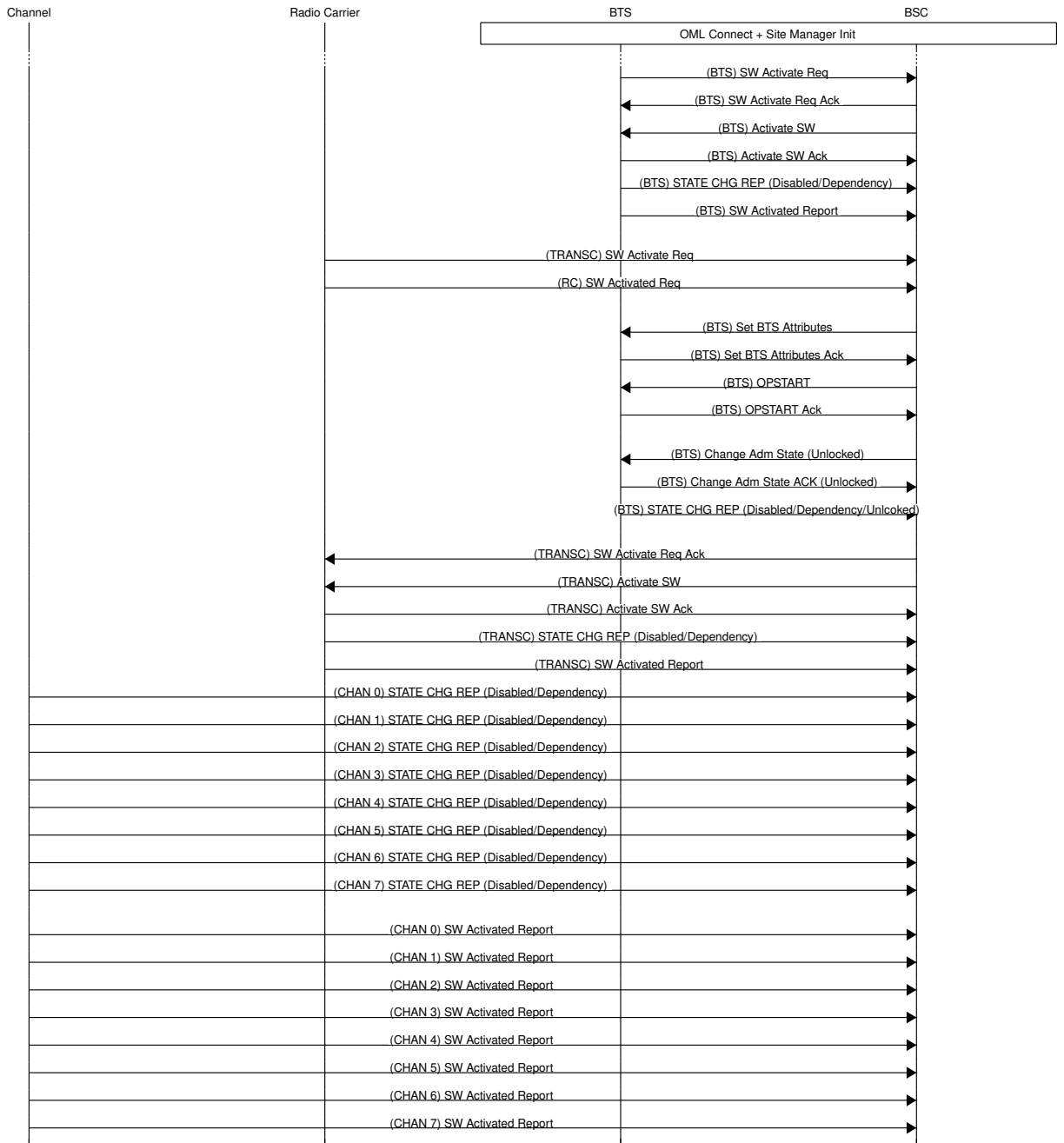

Figure 8: A-bis OML BTS bring-up (2/3)

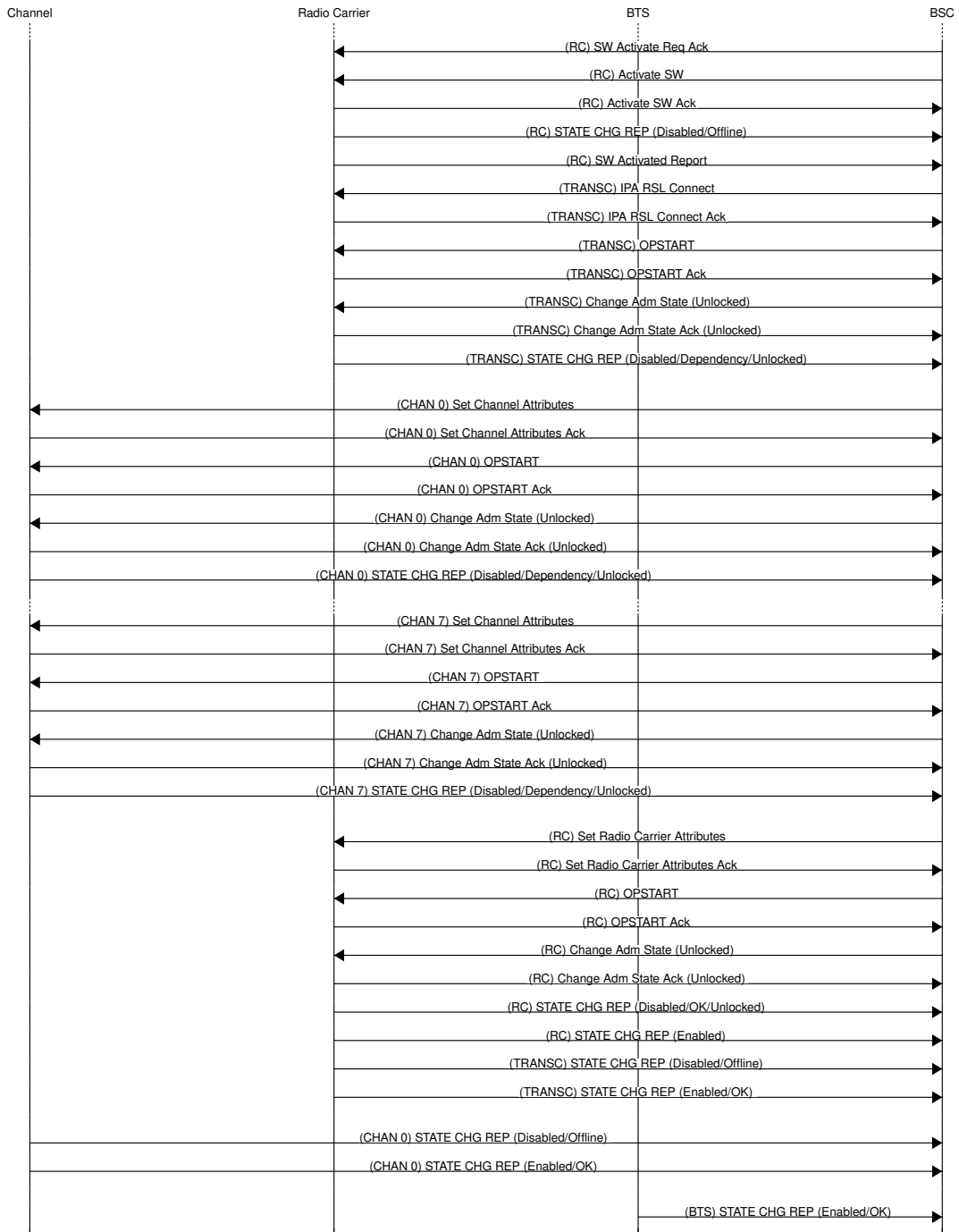

Figure 9: A-bis OML BTS bring-up (3/3)

Figure 8 shows:

1. Software Activation and associated state transitions of the BTS MO;
2. Setting of the BTS Attributes followed by OPSTART;
3. Software Activation and associated state transitions of the *Baseband Transceiver* MO;
4. Software Activation and associated state transitions of the *Radio Carrier* MO;

5. Once the *Baseband Transceiver* MO has its software activated, the *Channel* MOs (one for each timeslot) indicate their state change as well as software activation.

Figure 9 shows:

1. The *Radio Carrier* MO Software Activation;
2. The Request to the *Baseband Transceiver* MO to establish the RSL signalling connection to the BSC;
3. Subsequent OPSTART and Change of Administrative State on the *Baseband Transceiver* MO;
4. The following procedure takes place for each of the *Channel* MOs:
 - a. Set the Channel Attributes (such as channel combination),
 - b. OPSTART,
 - c. change the Administrative State to Unlocked,
 - d. followed by a State Change Event Report with the new state.
5. After all *Channel* MOs are initialized, the Radio Carrier goes through a similar procedure:
 - a. Set attributes,
 - b. OPSTART,
 - c. change Administrative State to Unlocked,
 - d. followed by a State Change Event Report with the new State (Enabled/OK)
6. All *Channel* MOs now also report their state as Enabled/OK.
7. Finally, the BTS reports its state as Enabled/OK.

5 Radio Signalling Link (RSL)

5.1 List of Messages

The following tables list the RSL messages used by OsmoBTS A-bis/IP, grouped by their level of compliance with 3GPP TS 48.058.

5.1.1 Messages Compliant With TS 48.058

Specific additions and limitations apply, see the linked sections.

Table 23: Messages compliant with TS 48.058

TS 48.058 §	This document §	Message	←-/→	Received/Sent by OsmoBTS
Radio link layer management messages				
8.3.1	-	DATA REQUEST	←	Received
8.3.2	-	DATA INDICATION	→	Sent
8.3.3	-	ERROR INDICATION	→	Sent
8.3.4	-	ESTABLISH REQUEST	←	Received
8.3.5	-	ESTABLISH CONFIRM	→	Sent
8.3.6	-	ESTABLISH INDICATION	→	Sent
8.3.7	-	RELEASE REQUEST	←	Received
8.3.8	-	RELEASE CONFIRM	→	Sent

Table 23: (continued)

TS 48.058 §	This document §	Message	←-/→	Received/Sent by OsmoBTS
8.3.9	-	RELEASE INDICATION	→	Sent
8.3.10	-	UNIT DATA REQUEST	←	Received
8.3.11	-	UNIT DATA INDICATION	→	Sent
DEDICATED CHANNEL MANAGEMENT MESSAGES				
8.4.1	Section 5.2.1	CHANNEL ACTIVATION	←	Received
8.4.2	Section 5.2.1	CHANNEL ACTIVATION ACKNOWLEDGE	→	Sent
8.4.3	Section 5.2.1	CHANNEL ACTIVATION NEGATIVE ACKNOWLEDGE	→	Sent
8.4.4	-	CONNECTION FAILURE INDICATION	→	Sent
8.4.5	-	DEACTIVATE SACCH	←	Received
8.4.6	-	ENCRYPTION COMMAND	←	Received
8.4.7	-	HANDOVER DETECTION	→	Sent
8.4.8	Section 5.2.2	MEASUREMENT RESULT	→	Sent
8.4.9	Section 5.2.3	MODE MODIFY	←	Received
8.4.10	-	MODE MODIFY ACKNOWLEDGE	→	Sent
8.4.11	-	MODE MODIFY NEGATIVE ACKNOWLEDGE	→	Sent
8.4.14	-	RF CHANNEL RELEASE	←	Received
8.4.15	Section 5.2.4	MS POWER CONTROL	←	Received
8.4.16	-	BS POWER CONTROL	←	Received
8.4.19	-	RF CHANNEL RELEASE ACKNOWLEDGE	→	Sent
8.4.20	Section 5.2.5	SACCH INFO MODIFY	←	Received
COMMON CHANNEL MANAGEMENT MESSAGES				
8.5.1	Section 5.2.6	BCCH INFORMATION	←	Received
8.5.2	-	CCCH LOAD INDICATION	→	Sent
8.5.3	Section 5.2.7	CHANNEL REQUIRED	→	Sent
8.5.4	-	DELETE INDICATION	→	Sent
8.5.5	Section 5.2.8	PAGING COMMAND	←	Received
8.5.6	-	IMMEDIATE ASSIGN COMMAND	←	Received
8.5.8	-	SMS BROADCAST COMMAND	←	Received
8.5.9	-	CBCH LOAD INDICATION	→	Sent
TRX MANAGEMENT MESSAGES				
8.6.1	Section 5.2.9	RF RESOURCE INDICATION	→	Sent
8.6.2	Section 5.2.10	SACCH FILLING	←	Received
8.6.4	-	ERROR REPORT	→	Sent

5.1.2 Messages Specific to OsmoBTS

Table 24: Messages specific to OsmoBTS, not found in 3GPP TS 48.058

This document §		Message	←-/→	Received/Sent by OsmoBTS
User Plane Transport Management (Section 5.3)				
Section 5.3.1	Section 5.7.1	RSL Create Connection (CRCX)	←	Received
	Section 5.7.2	RSL Create Connection (CRCX) ACK	→	Sent
	Section 5.7.3	RSL Create Connection (CRCX) NACK	→	Sent
Section 5.3.2	Section 5.7.4	RSL Modify Connection (MDCX)	←	Received
	Section 5.7.5	RSL Modify Connection (MDCX) ACK	→	Sent
	Section 5.7.6	RSL Modify Connection (MDCX) NACK	→	Sent

Table 24: (continued)

This document §		Message	←-/→	Received/Sent by OsmoBTS
Section 5.3.3	Section 5.7.8	RSL Delete Connection (DLCX)	←	Received
	Section 5.7.9	RSL Delete Connection (DLCX) ACK	→	Sent
	Section 5.7.10	RSL Delete Connection (DLCX) NACK	→	Sent
Section 5.3.4	Section 5.7.7	RSL Delete Connection (DLCX) Indication	→	Sent
IPA style PDCH Management (Section 5.4.1)				
Section 5.4.1.1	Section 5.7.11	RSL PDCH Activation	←	Received
	Section 5.7.12	RSL PDCH Activation ACK	→	Sent
	Section 5.7.13	RSL PDCH Activation NACK	→	Sent
Section 5.4.1.2	Section 5.7.14	RSL PDCH Deactivation	←	Received
	Section 5.7.15	RSL PDCH Deactivation ACK	→	Sent
	Section 5.7.16	RSL PDCH Deactivation NACK	→	Sent
COMMON CHANNEL MANAGEMENT MESSAGES				
Section 5.5	Section 5.7.17	Osmocom ETWS Command	←	Received

5.1.3 Messages Not Implemented by OsmoBTS

Table 25: 3GPP TS 48.058 messages not implemented by OsmoBTS

TS 48.058 §	Message
DEDICATED CHANNEL MANAGEMENT MESSAGES	
8.4.12	PHYSICAL CONTEXT REQUEST
8.4.13	PHYSICAL CONTEXT CONFIRM
8.4.17	PREPROCESS CONFIGURE
8.4.18	PREPROCESSED MEASUREMENT RESULT
8.4.21	TALKER DETECTION
8.4.22	LISTENER DETECTION
8.4.23	REMOTE CODEC CONFIGURATION REPORT
8.4.24	ROUND TRIP DELAY REPORT
8.4.25	PRE-HANDOVER NOTIFICATION
8.4.26	MULTIRATE CODEC MODIFICATION REQUEST
8.4.27	MULTIRATE CODEC MODIFICATION ACKNOWLEDGE
8.4.28	MULTIRATE CODEC MODIFICATION NEGATIVE ACKNOWLEDGE
8.4.29	MULTIRATE CODEC MODIFICATION PERFORMED
8.4.30	TFO REPORT
8.4.31	TFO MODIFICATION REQUEST
COMMON CHANNEL MANAGEMENT MESSAGES	
8.5.7	SMS BROADCAST REQUEST
8.5.10	NOTIFICATION COMMAND
TRX MANAGEMENT MESSAGES	
8.6.3	OVERLOAD
LOCATION SERVICES MESSAGES	
8.7.1	LOCATION INFORMATION

5.2 Message Limitation Details

5.2.1 Channel Activation

When used on a timeslot using the non-standard channel combination *NM_CHAN_C_OSMO_DYN* as configured by OML, the regular RSL channel activation procedures can not only be used for activation of circuit-switched channels, but also for activation of a PDCH.

See Section 5.4.2.

NOTE

Do not confuse this with the IPA style *PDCH ACT* type dynamic PDCH protocol employed by nanoBTS devices (Section 5.4.1).

5.2.2 Measurement Result

Conforms to 3GPP TS 48.058 § 8.4.8 with this limitation:

Table 26: *Measurement Result* IE limitations

TS 48.058 §	IE Name	Handling
9.3.37	MS Timing Offset	never sent by OsmoBTS

5.2.3 Mode Modify

Conforms to 3GPP TS 48.058 § 8.4.9 with these limitations:

Table 27: *Mode Modify* IE limitations

TS 48.058 §	IE Name	Handling
9.3.45	Main channel reference	<i>ignored</i>
9.3.53	MultiRate Control	<i>ignored</i>
9.3.54	Supported Codec Types	<i>ignored</i>

5.2.4 MS Power Control

Conforms to 3GPP TS 48.058 § 8.4.15 with these limitations:

Table 28: *MS Power Control* IE limitations

TS 48.058 §	IE Name	Handling
9.3.31	MS Power Parameters	<i>ignored</i>

5.2.5 SACCH Info Modify

Conforms to 3GPP TS 48.058 § 8.4.20, with these exceptions:

Table 29: *SACCH Info Modify* IE limitations

TS 48.058 §	IE Name	Handling
9.3.30	System Info Type	See below for available types
9.3.23	Starting Time	not supported, provokes an <i>Error Report</i> response

Table 30: *System Info Type* values that can occur on the SACCH

Value	Name
0x05	RSL_SYSTEM_INFO_5
0x06	RSL_SYSTEM_INFO_6
0x0d	RSL_SYSTEM_INFO_5bis
0x0e	RSL_SYSTEM_INFO_5ter
0x0f	RSL_SYSTEM_INFO_10
0x47	RSL_EXT_MEAS_ORDER
0x48	RSL_MEAS_INFO

5.2.6 BCCH Information

Conforms to 3GPP TS 48.058 § 8.5.1, with these limitations and extensions:

Table 31: *BCCH Information* IE details

TS 48.058 §	IE Name	Handling
9.3.30	System Info Type	See Section 5.2.5 for available types
9.3.11	L3 Info	This IE may be included instead of a 9.3.39 <i>Full BCCH Info</i> IE. The <i>Full BCCH Info</i> takes precedence over <i>L3 Info</i> . To stop SI transmission, both of these IEs must be omitted.

5.2.7 Channel Required

Conforms to 3GPP TS 48.058 § 8.5.3, with these limitations:

Table 32: *Channel Required* message IE details

TS 48.058 §	IE Name	Handling
9.3.16	Physical Context	never sent by OsmoBTS

5.2.8 Paging Command

Conforms to 3GPP TS 48.058 § 8.5.5, with these limitations:

Table 33: *Paging Command* message IE details

TS 48.058 §	IE Name	Handling
9.3.49	eMLPP Priority	<i>ignored</i>

Note

If adding the identity to the paging queue fails, the BSC is not notified in any way.

5.2.9 RF Resource Indication

For all osmo-bts variants, except osmo-bts-trx, this message does not conform to 3GPP TS 48.058 § 8.6.1, in that it omits the *Resource Information* IE that would contain the actual payload data, which renders this message void.

Table 34: *RF Resource Indication* message IE exceptions

TS 48.058 §	IE Name	Handling
9.3.21	Resource Information	DSP based osmo-bts variants omit this IE, though TS 48.058 specifies it as mandatory.

5.2.10 SACCH Filling

Conforms to 3GPP TS 48.058 § 8.6.2, with these limitations:

Table 35: *SACCH Filling* message IE limitations

TS 48.058 §	IE Name	Handling
9.3.30	System Info Type	See Section 5.2.5 for available types
9.3.23	Starting Time	<i>ignored</i>

5.3 User Plane Transport Management

This chapter defines the A-bis/IP specific RSL procedures that are introduced in addition to the 3GPP TS 48.058 standard procedures.

In classic A-bis over E1, user plane traffic is carried over 16kBps sub-slots of 64kBps E1 time-slots according to ETSI/3GPP TS 08.60. As the E1 line is a dedicated line between BTS and BSC, no further addressing information is required.

In A-bis/IP as described by the present document, new RSL procedures have been introduced to deal with the different properties of the underlying IP based transport medium.

5.3.1 RSL Create Connection (CRCX)

This procedure is used by the BSC to request the BTS to allocate + bind to a BTS-local UDP port for the subsequent transmission of user-plane data via RTP.

To do so, the BSC sends the **Create Connection (CRCX)** message. In case of successful outcome, the BTS responds with **Create Connection (CRCX) ACK**. In case of any error, the BTS responds with **Create Connection (CRCX) NACK**.

See Section 5.7.1, Section 5.7.2, Section 5.7.3

5.3.2 RSL Modify Connection (MDCX)

This procedure is used by the BSC to request the BTS to modify an already-bound BTS-local UDP port for user-plane RTP. It is used in particular to configure the remote IP address and UDP port to which the BTS shall send user-plane RTP traffic. This remote address is normally either a Media Gateway (MGW) of some sort, but could also be the RTP socket of the corresponding other leg of a mobile-to-mobile call.

To modify a user-plane connection, the BSC sends the **Modify Connection** message. In case of successful outcome, the BTS responds with **Modify Connection (MDCX) ACK**. In case of any error, the BTS responds with **Modify Connection (MDCX) NACK**.

See Section 5.7.4, Section 5.7.5, Section 5.7.6

5.3.3 RSL Delete Connection (DLCX)

This procedure is used by the BSC to request the BTS to delete an already-existing BTS-local UDP port for user-plane RTP.

To delete a user-plane connection, the BSC sends the **Delete Connection (DLCX)** message. In case of successful outcome, the BTS responds with **Delete Connection (DLCX) ACK**. In case of any error, the BTS responds with **Delete Connection (DLCX) NACK**.

See Section 5.7.8, Section 5.7.9, Section 5.7.10

5.3.4 RSL Delete Connection (DLCX) Indication

When a BTS-local UDP connection for user-plane RTP is automatically released at the time of RF CHANNEL RELEASE, the BTS sends a unilateral, non-acknowledged **RSL Delete Connection (DLCX) Indication** to the BSC.

See Section 5.7.7

5.4 Dynamic Channel Combinations

In the classic data model established by ETSI/3GPP for A-bis, each timeslot (channel) is configured using a static channel combination by means of A-bis OML. Particularly in presence of GPRS services, this is very inflexible and leads to inefficient use of air interface resources.

As such, several methods have been implemented to overcome this limitation. The fundamental operation can be outlined like this:

- Configuration of a particular *dynamic* channel combination via OML
- activation of TCH works like on a classic TCH channel combination
- activation of PDCH requires some specific PDCH activation procedure

There are two variants implemented in the OsmoBTS A-bis dialect:

5.4.1 IPA Style Dynamic Channels

This method is used when OML uses *NM_CHAN_C_IPAC_TCHFull_PDCH* (0x80) as channel combination for the given timeslot.

IPA style refers to *ip.access* compatible PDCH activation and deactivation.

When the IPA style dynamic channel combination *TCH/F or PDCH* is set, the non-standard *PDCH ACTIVATE* (Section 5.4.1.1) and *PDCH DEACTIVATE* (Section 5.4.1.2) procedures are used for switching an idle channel into PDCH mode and back into idle mode.

When the channel is used as TCH/F, regular circuit-switched activation is performed, like on any traditional TCH/F. However, the BSC must make sure to first disable the PDCH on the timeslot, before activating it as TCH/F. Likewise, any circuit-switched TCH/F on the channel must be deactivated using standard RSL signalling, before the specific PDCH related procedures are used to enable the PDCH.

5.4.1.1 PDCH Activate

This procedure is used by the BSC to request the BTS to activate an IPA style dynamic TCH/F+PDCH channel in PDCH mode.

The operation is not supported on any other physical channel type.

See Section 5.7.11, Section 5.7.12, Section 5.7.13

5.4.1.2 PDCH Deactivate

This procedure is used by the BSC to request the BTS to deactivate an active PDCH on any an IPA style dynamic TCH/F+PDCH channel.

The operation is not supported on any other physical channel type.

See Section 5.7.14, Section 5.7.15, Section 5.7.16

5.4.1.3 IPA Style Dynamic Switchover Example

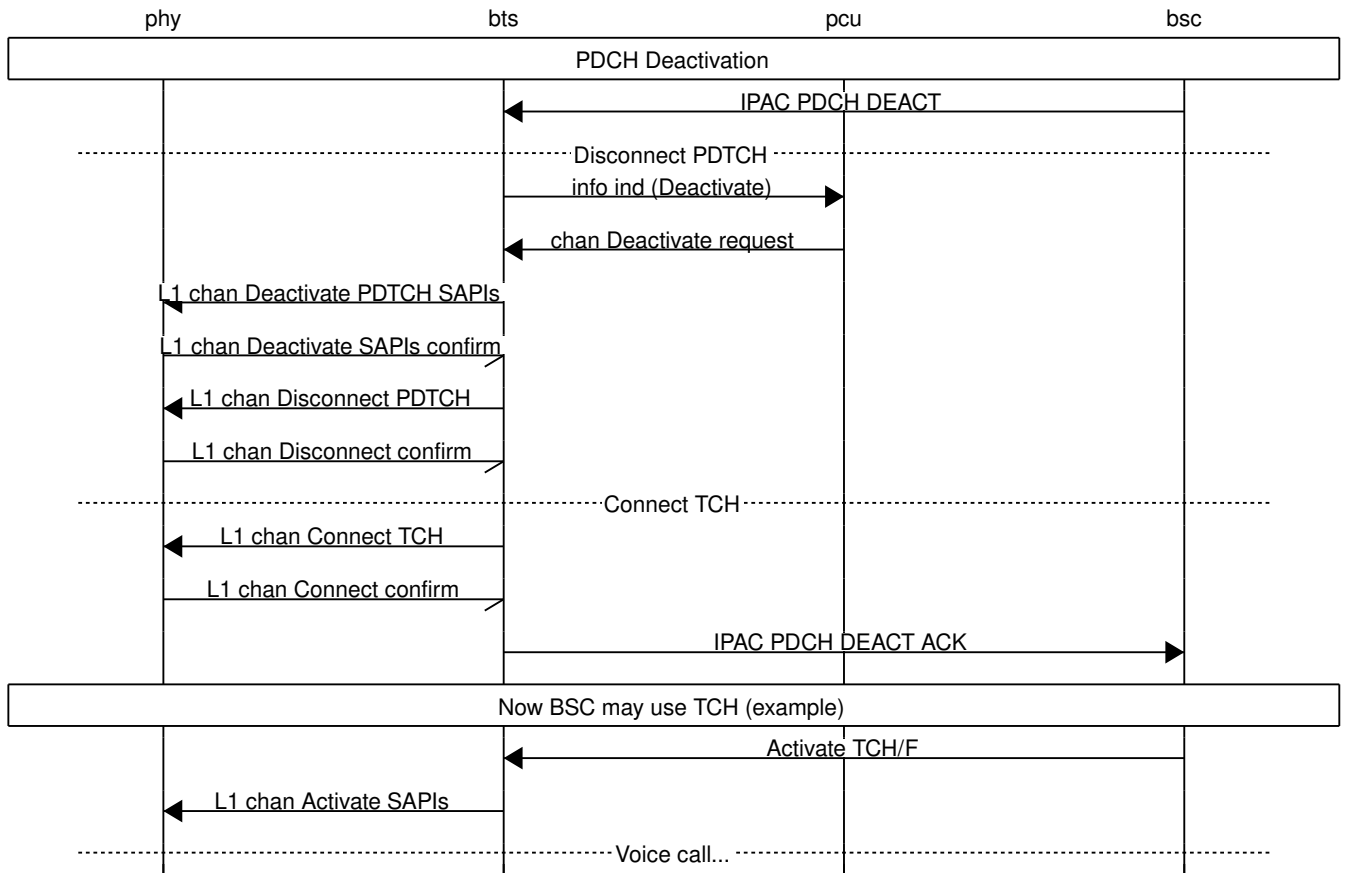

Figure 10: Part 1: example for dynamic channel switchover, for IPA style dynamic timeslots

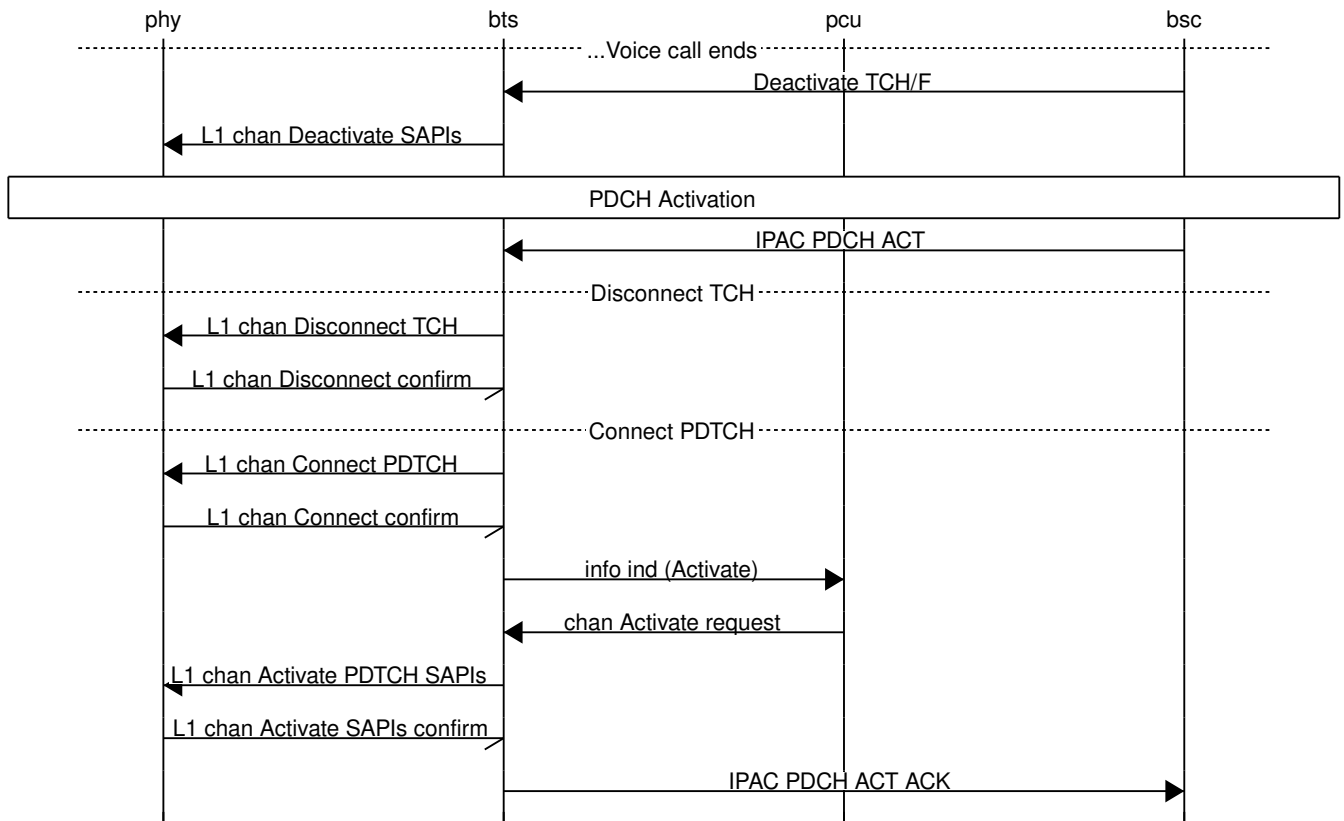

Figure 11: Part 2: example for dynamic channel switchover, for IPA style dynamic timeslots

5.4.2 Osmocom Style Dynamic Channels

This method is in use when OML uses *NM_CHANCOSMO_DYN* (0x90) for the given time-slot.

The activation of PDCH is performed by using the regular *RSL CHANNEL ACTIVATE* procedure according to Section 5.2.1, with these modifications:

- The *C-bits* part of the *Channel Number* IE take the non-standard binary value 11000 (C5 through C1 as seen in 3GPP TS 48.058 § 9.3.1).
- The *A-bits* part of the *Activation Type* IE take the non-standard binary value 1111, with an additional fourth bit (add A4 to A3 through A1 as seen in 3GPP TS 48.058 § 9.3.3; all remaining reserved bits as well as the *R* bit are coded as zero).
- The normally mandatory *Channel Mode* IE is omitted; none of the optional IEs are included.

Hence the message consists of exactly these IEs:

Table 36: PDCH type *Channel Activation* message IEs

TS 48.058 §	IE Name	Handling
9.1	Message discriminator	Dedicated Channel Management
9.2	Message type	CHANnel ACTIVation
9.3.1	Channel number	<i>C-bits</i> 11000, plus TS bits as usual
9.3.3	Activation type	<i>A-bits</i> 1111

5.4.2.1 Osmocom Style Dynamic Switchover Example

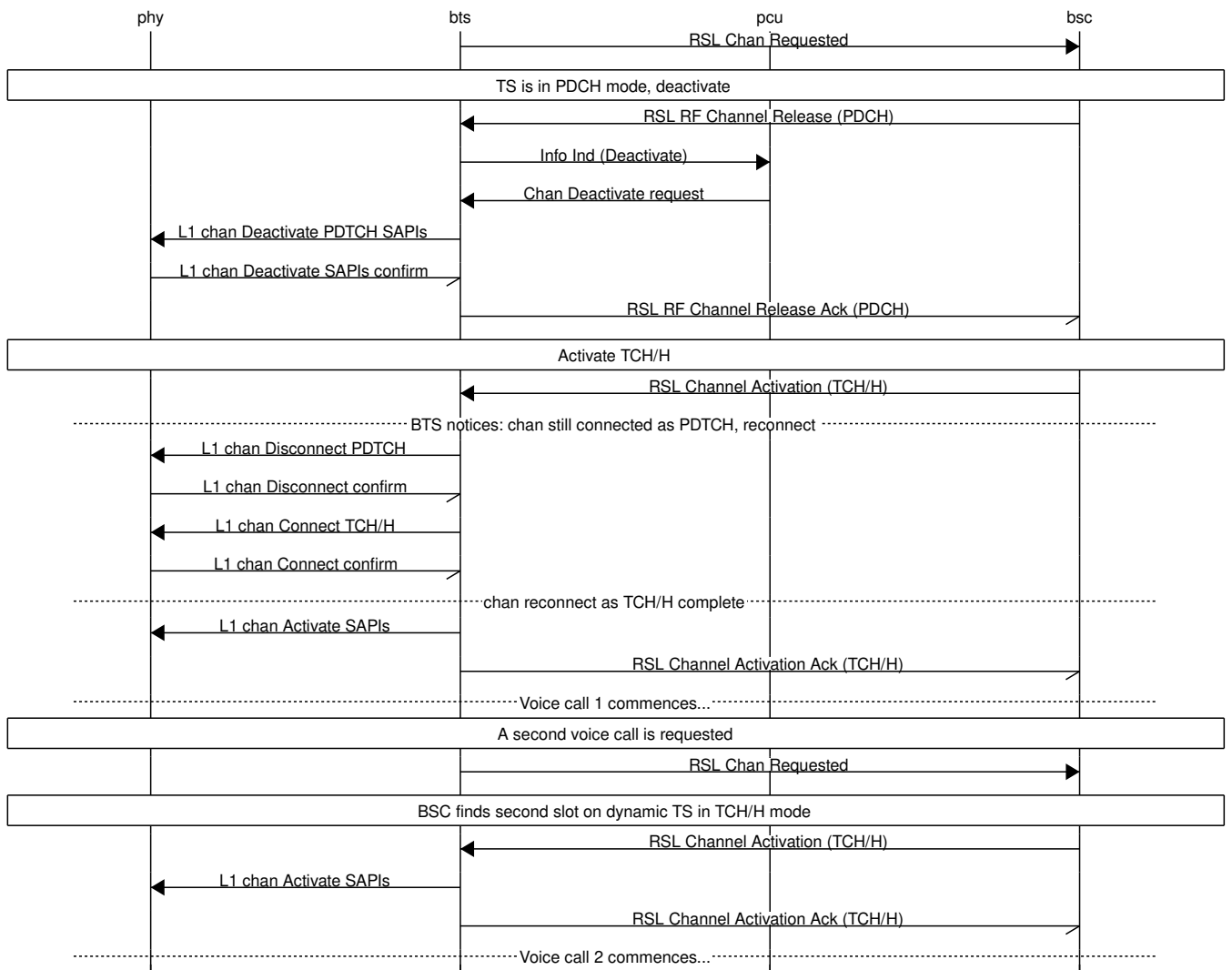

Figure 12: Part 1: example for dynamic channel switchover, for Osmocom style dynamic timeslots

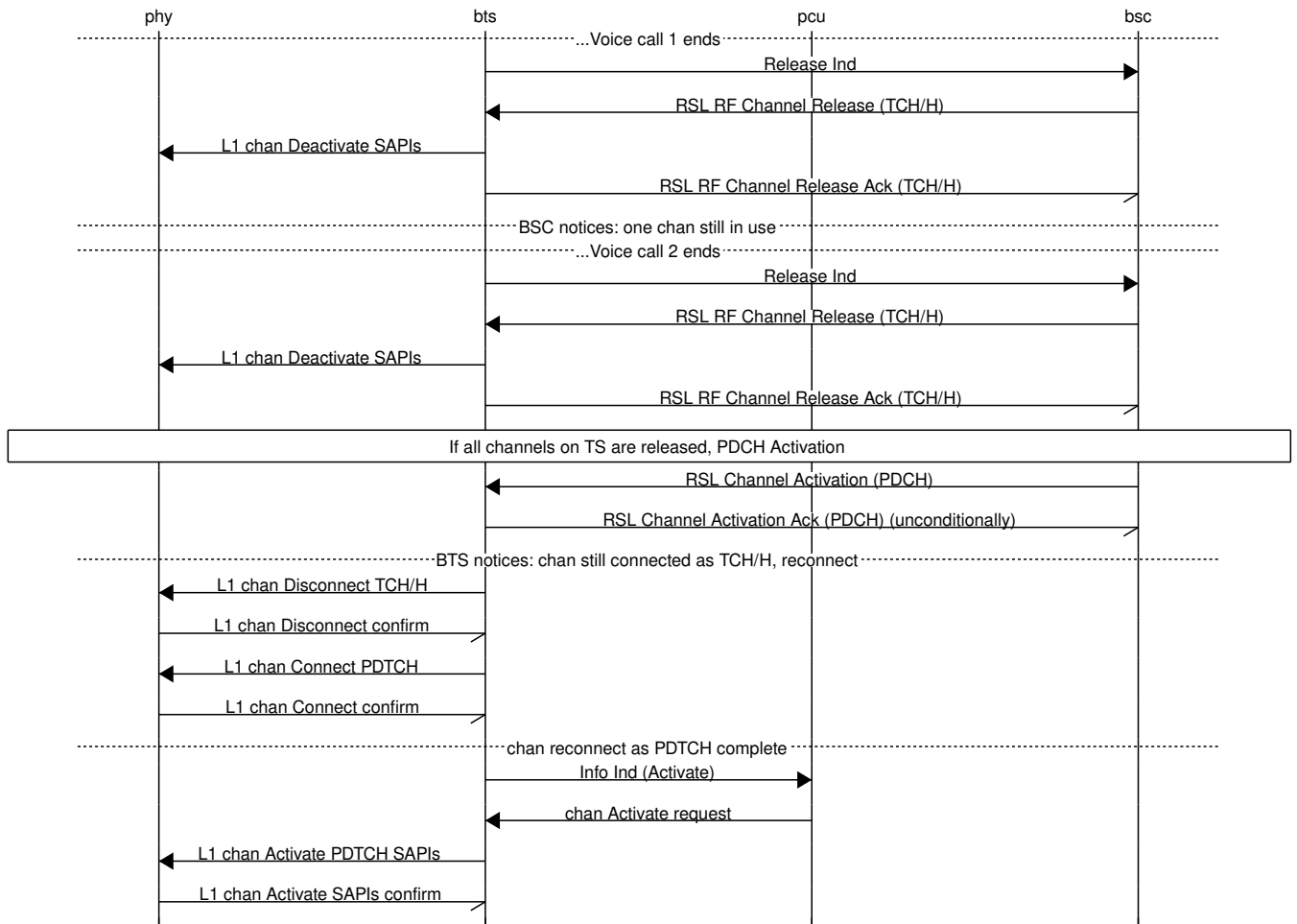

Figure 13: Part 2: example for dynamic channel switchover, for Osmocom style dynamic timeslots

5.5 ETWS (Earthquake and Tsunami Warning System)

ETWS as specified in 3GPP TS 23.041 includes not only notification via SMSCB, but also so-called Primary Notifications (PN). The ETWS PN are transmitted

- by the BSC to all subscribers with active dedicated channels
- by the BTS on the PCH to all subscribers in idle mode
- by the PCU on the PACCH to all subscribers with active TBF

Unfortunately, 3GPP forgot to update their specifications with any information as to how the ETWS PN is transmitted from BSC to BTS in a portable way, and Osmocom had to invent their own non-standard signaling for it.

See Section 5.7.17 for the Osmocom implementation.

5.6 BCCH carrier power reduction operation

According to 3GPP TS 45.008, section 7.1, the BCCH carrier (sometimes called C0) of a BTS shall maintain discontinuous Downlink transmission at full power in order to stay "visible" to the mobile stations. Because of that, early versions of this 3GPP document prohibited BS power reduction on C0. However, a new feature was introduced version 13.0.0 (2015-11) - "BCCH carrier power reduction operation".

This is a special mode of operation, in which the variation of RF power level for some timeslots is relaxed for the purpose of energy saving. In other words, the output power on some timeslots, except the timeslot(s) carrying BCCH/CCCH, can be lower than the full power. In this case the maximum allowed difference is 6 dB.

Unfortunately, 3GPP did not specify in which way the BTS is instructed to activate and deactivate the BCCH carrier power reduction mode. Osmocom had to invent their own non-standard approach: the BSC needs to send *BS POWER CONTROL* message with the *Channel Number* IE set to 0x80 (BCCH) and the *Message Discriminator* set to 0x06 (Common Channel Management messages).

5.7 Message Formats and Contents

5.7.1 Create Connection (CRCX)

This message is sent by the BSC to the BTS to request the creation of a user-plane RTP connection for the specified **Channel number**.

INFORMATION ELEMENT	REFERENCE	PRESENCE	FORMAT	LENGTH
Message discriminator	48.058 9.1	M	V	1
Message type	Section 5.8.1	M	V	1
Channel number	48.058 9.3.1	M	TV	2
Destination IP Address	Section 5.8.4	O	TV	5
Destination IP Port	Section 5.8.5	O	TV	3
IP Speech Mode	Section 5.8.7	O	TV	2
RTP Payload Type 2	Section 5.8.11	O	TV	2
RTP CSD Format	Section 5.8.16	O	TV	2

5.7.2 Create Connection (CRCX) ACK

This message is sent by the BTS to the BSC to acknowledge the successful outcome of creating a user-plane RTP connection. It is sent in response to the **Create Connection (CRCX)**.

INFORMATION ELEMENT	REFERENCE	PRESENCE	FORMAT	LENGTH
Message discriminator	48.058 9.1	M	V	1
Message type	Section 5.8.1	M	V	1
Channel number	48.058 9.3.1	M	TV	2
Connection Id	Section 5.8.10	M	TV	3
Source IP Address	Section 5.8.8	O	TV	5
Source IP Port	Section 5.8.6	O	TV	3
RTP Payload Type 2	Section 5.8.11	O	TV	2

5.7.3 Create Connection (CRCX) NACK

This message is sent by the BTS to the BSC to signal the unsuccessful outcome of creating a user-plane RTP connection. It is sent in response to the **Create Connection (CRCX)**.

INFORMATION ELEMENT	REFERENCE	PRESENCE	FORMAT	LENGTH
Message discriminator	48.058 9.1	M	V	1
Message type	Section 5.8.1	M	V	1
Channel number	48.058 9.3.1	M	TV	2
Destination IP Address	Section 5.8.4	O	TV	5
Destination IP Port	Section 5.8.5	O	TV	3
Cause	48.058 9.3.26	O	TLV	>= 3

5.7.4 Modify Connection (MDCX)

This message is sent by the BSC to the BTS to modify the properties of a user-plane RTP connection.

INFORMATION ELEMENT	REFERENCE	PRESENCE	FORMAT	LENGTH
Message discriminator	48.058 9.1	M	V	1
Message type	Section 5.8.1	M	V	1
Channel number	48.058 9.3.1	M	TV	2
Connection Id	Section 5.8.10	O	TV	3
Destination IP Address	Section 5.8.4	O	TV	5
Destination IP Port	Section 5.8.5	O	TV	3
IP Speech Mode	Section 5.8.7	O	TV	2
RTP Payload Type 2	Section 5.8.11	O	TV	2
RTP CSD Format	Section 5.8.16	O	TV	2

5.7.5 Modify Connection (MDCX) ACK

This message is sent by the BTS to the BSC to acknowledge the successful modification of a user-plane RTP connection. It is sent in response to a **Modify Connection (MDCX)**

INFORMATION ELEMENT	REFERENCE	PRESENCE	FORMAT	LENGTH
Message discriminator	48.058 9.1	M	V	1
Message type	Section 5.8.1	M	V	1
Channel number	48.058 9.3.1	M	TV	2
Connection Id	Section 5.8.10	O	TV	3
Source IP Address	Section 5.8.8	C	TV	5
Source IP Port	Section 5.8.6	C	TV	3
RTP Payload Type 2	Section 5.8.11	O	TV	2

5.7.6 Modify Connection (MDCX) NACK

This message is sent by the BTS to the BSC to signal the unsuccessful outcome of modifying the user-plane RTP connection for the specified Channel number. It is sent in response to the **Modify Connection (MDCX)**.

INFORMATION ELEMENT	REFERENCE	PRESENCE	FORMAT	LENGTH
Message discriminator	48.058 9.1	M	V	1
Message type	Section 5.8.1	M	V	1
Channel number	48.058 9.3.1	M	TV	2
Cause	48.058 9.3.26	M	TLV	>= 3

5.7.7 Delete Connection (DLCX) Indication

This message is sent by the BTS to indicate the automatic deletion of a BTS-local UDP connection for user-plane RTP traffic at the time of RF Channel release.

INFORMATION ELEMENT	REFERENCE	PRESENCE	FORMAT	LENGTH
Message discriminator	48.058 9.1	M	V	1
Message type	Section 5.8.1	M	V	1
Channel number	48.058 9.3.1	M	TV	2
Connection Id	Section 5.8.10	M	TV	3
Connection Id	Section 5.8.9	M	TV	3
Cause	48.058 9.3.26	M	TLV	>= 3

5.7.8 Delete Connection (DLCX)

This message is sent by the BSC to the BTS to request the disconnection of a user-plane RTP connection for the specified Channel number.

INFORMATION ELEMENT	REFERENCE	PRESENCE	FORMAT	LENGTH
Message discriminator	48.058 9.1	M	V	1
Message type	Section 5.8.1	M	V	1
Channel number	48.058 9.3.1	M	TV	2
Connection Id	Section 5.8.10	O	TV	3

5.7.9 Delete Connection (DLCX) ACK

This message is sent by the BTS to signal the successful outcome of deleting the user-plane RTP connection for the specified Channel number. It is sent in response to the **Delete Connection (DLCX)**.

INFORMATION ELEMENT	REFERENCE	PRESENCE	FORMAT	LENGTH
Message discriminator	48.058 9.1	M	V	1
Message type	Section 5.8.1	M	V	1
Channel number	48.058 9.3.1	M	TV	2
Connection Id	Section 5.8.10	O	TV	3
Connection Statistics	Section 5.8.9	C	TV	29

5.7.10 Delete Connection (DLCX) NACK

This message is sent by the BTS to signal the unsuccessful outcome of deleting the user-plane RTP connection for the specified Channel number. It is sent in response to the **Delete Connection (DLCX)**.

INFORMATION ELEMENT	REFERENCE	PRESENCE	FORMAT	LENGTH
Message discriminator	48.058 9.1	M	V	1
Message type	Section 5.8.1	M	V	1
Channel number	48.058 9.3.1	M	TV	2
Connection Id	Section 5.8.10	O	TV	3
Cause	48.058 9.3.26	M	TLV	>= 3

5.7.11 PDCH Activate

This message is sent by the BSC to request the activation of a PDCH on a IPA style dynamic TCH/F+PDCH channel.

INFORMATION ELEMENT	REFERENCE	PRESENCE	FORMAT	LENGTH
Message discriminator	48.058 9.1	M	V	1
Message type	Section 5.8.1	M	V	1
Channel number	48.058 9.3.1	M	TV	2

NOTE

This message is **not** used by Osmocom style dynamic channels

5.7.12 PDCH Activate ACK

This message is sent by the BTS to confirm the successful activation of a PDCH on a IPA style dynamic TCH/F+PDCH channel.

INFORMATION ELEMENT	REFERENCE	PRESENCE	FORMAT	LENGTH
Message discriminator	48.058 9.1	M	V	1
Message type	Section 5.8.1	M	V	1
Channel number	48.058 9.3.1	M	TV	2
Frame Number	48.058 9.3.8	O	TV	3

NOTE

This message is **not** used by Osmocom style dynamic channels

5.7.13 PDCH Activate NACK

This message is sent by the BTS to reject the successful activation of a PDCH on a IPA style dynamic TCH/F+PDCH channel.

INFORMATION ELEMENT	REFERENCE	PRESENCE	FORMAT	LENGTH
Message discriminator	48.058 9.1	M	V	1
Message type	Section 5.8.1	M	V	1
Channel number	48.058 9.3.1	M	TV	2
Cause	48.058 9.3.26	M	TLV	>= 3

NOTE

This message is **not** used by Osmocom style dynamic channels

5.7.14 PDCH Deactivate

This message is sent by the BSC to request the deactivation of a PDCH on a IPA style dynamic TCH/F+PDCH channel.

INFORMATION ELEMENT	REFERENCE	PRESENCE	FORMAT	LENGTH
Message discriminator	48.058 9.1	M	V	1
Message type	Section 5.8.1	M	V	1
Channel number	48.058 9.3.1	M	TV	2

NOTE

This message is **not** used by Osmocom style dynamic channels

5.7.15 PDCH Deactivate ACK

This message is sent by the BTS to confirm the successful deactivation of a PDCH on a IPA style dynamic TCH/F+PDCH channel.

INFORMATION ELEMENT	REFERENCE	PRESENCE	FORMAT	LENGTH
Message discriminator	48.058 9.1	M	V	1
Message type	Section 5.8.1	M	V	1
Channel number	48.058 9.3.1	M	TV	2

NOTE

This message is **not** used by Osmocom style dynamic channels

5.7.16 PDCH Deactivate NACK

This message is sent by the BTS to reject the deactivation of a PDCH on a IPA style dynamic TCH/F+PDCH channel.

INFORMATION ELEMENT	REFERENCE	PRESENCE	FORMAT	LENGTH
Message discriminator	48.058 9.1	M	V	1
Message type	Section 5.8.1	M	V	1
Channel number	48.058 9.3.1	M	TV	2
Cause	48.058 9.3.26	M	TLV	>= 3

NOTE

This message is **not** used by Osmocom style dynamic channels

5.7.17 Osmocom ETWS Command

This message is sent by the BSC to transfer the ETWS Primary Notification (PN) from BSC to BTS and enable/disable transmission of ETWS PN by the BTS. For more information about ETWS, see 3GPP TS 23.041.

If the ETWS PN length is > 0, the BTS will immediately start transmission of the received ETWS PN on the PCH using P1 Rest Octets. It will also forward the ETWS PN to the PCU to enable the PCU to transmit it via PACCH on active TBF.

If the ETWS PN length is 0, the BTS will stop any ETWS PN broadcast via the PCH.

The Channel Number IE is set to the Downlink CCCH (PCH).

INFORMATION ELEMENT	REFERENCE	PRESENCE	FORMAT	LENGTH
Message discriminator	48.058 9.1	M	V	1
Message type	Section 5.8.1	M	V	1
Channel number	48.058 9.3.1	M	TV	2
SMSCB Message	48.058 9.3.42	M	TLV	2-58

5.8 Information Element Codings

5.8.1 A-bis/IP specific RSL Message discriminators

The following message discriminators are used in addition to those indicated in 3GPP TS 48.058 Section 9.1:

Table 37: OsmoBTS specific new message discriminators

Message Type	Message	This document §
0x70	Create Connection (CRCX)	Section 5.7.1
0x71	Create Connection (CRCX) ACK	Section 5.7.2
0x72	Create Connection (CRCX) NACK	Section 5.7.3
0x73	Modify Connection (MDCX)	Section 5.7.4
0x74	Modify Connection (MDCX) ACK	Section 5.7.5
0x75	Modify Connection (MDCX) NACK	Section 5.7.6
0x76	Delete Connection (DLCX) Indication	Section 5.7.7
0x77	Delete Connection (DLCX)	Section 5.7.8
0x78	Delete Connection (DLCX) ACK	Section 5.7.9
0x79	Delete Connection (DLCX) NACK	Section 5.7.10
0x7f	Osmocom ETWS Command	Section 5.7.17
0x48	PDCH Activate	Section 5.7.11
0x49	PDCH Activate ACK	Section 5.7.12

Table 37: (continued)

Message Type	Message	This document §
0x4a	PDCH Activate NACK	Section 5.7.13
0x4b	PDCH Deactivate	Section 5.7.14
0x4c	PDCH Deactivate ACK	Section 5.7.15
0x4d	PDCH Deactivate NACK	Section 5.7.16

5.8.2 A-bis/IP specific RSL IEIs

The following Information Element Identifiers (IEIs) are used in addition to those indicated in 3GPP TS 48.058 Section 9.3:

Table 38: A-bis/IP specific information elements

IEI	Name	This document §
0x01	RSL_IE_CHAN_NR	Section 5.8.3
0x60	RSL_IE_OSMO_REP_ACCH_CAP	Section 5.8.12
0x61	RSL_IE_OSMO_TRAINING_SEQUENCE	Section 5.8.13
0x62	RSL_IE_OSMO_TEMP_OVP_ACCH_CAP	Section 5.8.14
0x63	RSL_IE_OSMO_OSMUX_CID	Section 5.8.15
0xf0	RSL_IE_IPAC_REMOTE_IP	Section 5.8.4
0xf1	RSL_IE_IPAC_REMOTE_PORT	Section 5.8.5
0xf3	RSL_IE_IPAC_LOCAL_PORT	Section 5.8.6
0xf4	RSL_IE_IPAC_SPEECH_MODE	Section 5.8.7
0xf5	RSL_IE_IPAC_LOCAL_IP	Section 5.8.8
0xf6	RSL_IE_IPAC_CONN_STAT	Section 5.8.9
0xf8	RSL_IE_IPAC_CONN_ID	Section 5.8.10
0xf9	RSL_IE_IPAC_RTP_CSD_FORMAT	Section 5.8.16
0xfc	RSL_IE_IPAC_RTP_PAYLOAD2	Section 5.8.11

5.8.3 RSL_IE_CHAN_NR

This information element is coded as described in 3GPP TS 48.058 Section 9.3.1, but in addition supports the following vendor specific values:

Table 39: RSL Channel Number extensions

C5	C4	C3	C2	C1	Description
1	1	0	0	0	PDCH <1>
1	1	0	0	1	CBCH on SDCCH4
1	1	0	1	0	CBCH on SDCCH8
1	1	1	0	1	VAMOS TCH/F <2>
1	1	1	1	T	VAMOS TCH/H <2>

<1> This extension is only valid on an Osmocom-style dynamic channel, having configured the *NM_CHAN_C_IPAC_TCHFull_PDCH* channel combination by OML. <2> These Osmocom specific values are used by osmo-bsc to address logical channels on the shadow timeslots in VAMOS mode, iff the BTS is an osmo-bts and VAMOS capable.

The TN-Bits are not re-defined in this case but use the same encoding as specified in TS 48.058 Section 9.3.1.

5.8.4 RSL_IE_IPAC_REMOTE_IP

This information element contains the remote (MGW side) IPv4 address in network byte order. It is encoded as fixed-size element with one byte IEI followed by four bytes IPv4 address.

5.8.5 RSL_IE_IPAC_REMOTE_PORT

This information element contains the remote (MGW side) UDP port in network byte order. It is encoded as fixed-size element with one byte IEI followed by two bytes UDP port number.

5.8.6 RSL_IE_IPAC_LOCAL_PORT

This information element contains the local (BTS side) IPv4 address in network byte order. It is encoded as fixed-size element with one byte IEI followed by two bytes UDP port number.

5.8.7 RSL_IE_IPAC_SPEECH_MODE

This information element encodes the speech mode. It is set according to the voice codec used on the connection. It is encoded as a fixed-size element of two bytes, with one byte IEI followed by one byte Speech mode indicator.

Table 40: A-bis/IP Speech Mode Indicator Values

Value	Description
0x00	TCH/F with FR codec
0x01	TCH/F with EFR codec
0x02	TCH/F with AMR codec
0x03	TCH/H with HR codec
0x05	TCH/H with AMR codec

5.8.8 RSL_IE_IPAC_LOCAL_IP

This information element contains the local (BTS side) IPv4 address in network byte order. It is encoded as fixed-size element with one byte IEI followed by four bytes IPv4 address.

5.8.9 RSL_IE_IPAC_CONN_STAT

This information element contains statistics about the RTP connection.

It is encoded as 30 bytes, with the first byte as IEI, the second byte as length (=28), and 28 bytes fixed-length payload encoded as follows:

Table 41: A-bis/IP Connection Statistics

Offset	Size	Description
0	4	Total number of RTP packets sent
4	4	Total number of octets sent
8	4	Total number of RTP packets received
12	4	Total number of octets received
16	4	Total number of lost packets in Rx direction
20	4	Inter-arrival Jitter

Table 41: (continued)

Offset	Size	Description
24	4	Average transmission delay

All the above values are encoded in network byte order.

A detailed definition of the individual values is given in RFC 1889.

5.8.10 RSL_IE_IPAC_CONN_ID

This IE is a TV with a value length of two bytes. The value is a 16 bit connection ID in network byte order.

5.8.11 RSL_IE_IPAC_RTP_PAYLOAD2

This information element contains the RTP payload identifier, which is used in the PT (Payload Type) field of the RTP header in subsequent transmissions of the RTP flow.

5.8.12 RSL_IE_OSMO_REP_ACCH_CAP

This is a one byte length TLV IE that is used to enable or disable repeated ACCH capabilities on the BTS side during Channel Activation and Mode Modify.

The IE contains a bitfield in the lower nibble in order to set the ACCH repetition policy for each of the two channel types individually. Depending on the state of the bits (see table below) the ACCH repetition mode is either enabled or disabled completely.

The lower 3 bit of the higher nibble are used to signal an RXQUAL threshold to set the BER on which UL-SACCH or DL-FACCH repetition shall be turned on. If the field is set to 0, then UL-SACCH and DL-FACCH will be always on. DL-FACCH will also be turned on automatically as soon as the MS requests a DL-SACCH repetition.

If the IE is not present, then ACCH repetition completely is disabled.

bit	7	6 - 4	3	2	1	0
byte at offset 0	0	RXQUAL	UL-SACCH	DL-SACCH	DL-FACCH/ALL	DL-FACCH/CMD

(Bits 7 is reserved for future use and must be set to zero.)

5.8.13 RSL_IE_OSMO_TRAINING_SEQUENCE

This TLV IE instructs the BTS to use a specific training sequence set and training sequence code for a given lchan. It is sent by OsmoBSC in RSL CHANNEL ACTIVATION and MODE MODIFY messages to the BTS, iff the BTS is VAMOS-capable, i.e. if an Abis-over-IP connected BTS indicated BTS_FEAT_VAMOS in the OML BTS features (Manufacturer Id information element, see Section 4.6.22).

If this information element is present, the receiver shall ignore any other training sequence set and training sequence code bits from other information elements of the same RSL message.

This is an Osmocom-specific extension of the RSL layer, which was added to express more than two TSC sets. For VAMOS operation, OsmoBSC selects from one of four separate training sequence codings per modulation scheme, while usual RSL IEs are only able to express a single-bit TSC set number. For clarity, this IE contains both the TSC set and the TSC in one IE, and is defined as overruling any other IEs containing TSC or TSC set numbers.

The first value octet indicates the training sequence set, and the second octet indicates the training sequence code to be used. Receiving values from a reserved value range should be considered an error condition.

Table 42: RSL_IE_OSMO_TRAINING_SEQUENCE

IE octet	value
octet 1	RSL_IE_OSMO_TRAINING_SEQUENCE IEI (0x61)
octet 2	length of the value part (2)
octet 3	TSC set
octet 4	TSC

The training sequence set (TSC set) is coded like the *CS Domain TSC Set* bits, as defined in the *Extended TSC Set* IE in 3GPP TS 44.018 10.5.2.82 [3gpp-ts-44-018], and corresponds to the *TSC Set* as defined in 3GPP TS 45.002 [3gpp-ts-45-002]. The encoded training sequence set number ranges from 0 to 3, any other values are reserved for future use. The encoded 0 corresponds to TSC Set 1, see Table 43.

Table 43: TSC set (octet 3) coding

octet 3 value	interpretation
0	<i>TSC Set 1</i> as in 3GPP TS 45.002
1	<i>TSC Set 2</i>
2	<i>TSC Set 3</i>
3	<i>TSC Set 4</i>
4..255	reserved values

The training sequence code (TSC) corresponds to the *TSC* bits as defined in the *Channel Description 2* IE in 3GPP TS 44.018 10.5.2.5a [3gpp-ts-44-018]. The training sequence code ranges from 0 to 7, any other values are reserved for future use.

Table 44: TSC (octet 4) coding

octet 4 value	interpretation
0	<i>Training Sequence Code (TSC) 0</i> as in 3GPP TS 45.002
1	<i>Training Sequence Code (TSC) 1</i>
2	<i>Training Sequence Code (TSC) 2</i>
3	<i>Training Sequence Code (TSC) 3</i>
4	<i>Training Sequence Code (TSC) 4</i>
5	<i>Training Sequence Code (TSC) 5</i>
6	<i>Training Sequence Code (TSC) 6</i>
7	<i>Training Sequence Code (TSC) 7</i>
8..255	reserved values

5.8.14 RSL_IE_OSMO_TEMP_OVP_ACCH_CAP

FIXME: this IE has been defined, but remains to be documented.

5.8.15 RSL_IE_OSMO_OSMUX_CID

FIXME: this IE has been defined, but remains to be documented.

5.8.16 RSL_IE_IPAC_RTP_CSD_FORMAT

This information element contains the RTP Circuit Switched Data format.

Table 45: A-bis/IP RTP CSD Format

Offset	Size	Description
0	4	RTP CSD Format D
4	4	RTP CSD Format IR

Table 46: A-bis/IP RTP CSD Format D Values

Value	Description
0	External TRAU format
1	Non-TRAU Packed format
2	TRAU within the BTS
3	IWF-Free BTS-BTS Data

Table 47: A-bis/IP RTP CSD Format IR Values

Value	Description
0	8 kb/s
1	16 kb/s
2	32 kb/s
3	48 kb/s

5.9 A-bis RSL Initialization / BTS bring-up

Upon receiving the *IPA RSL CONNECT* OML message by the respective *Baseband Transceiver* MO, the BTS proceeds with establishing a separate TCP connection for the given TRX.

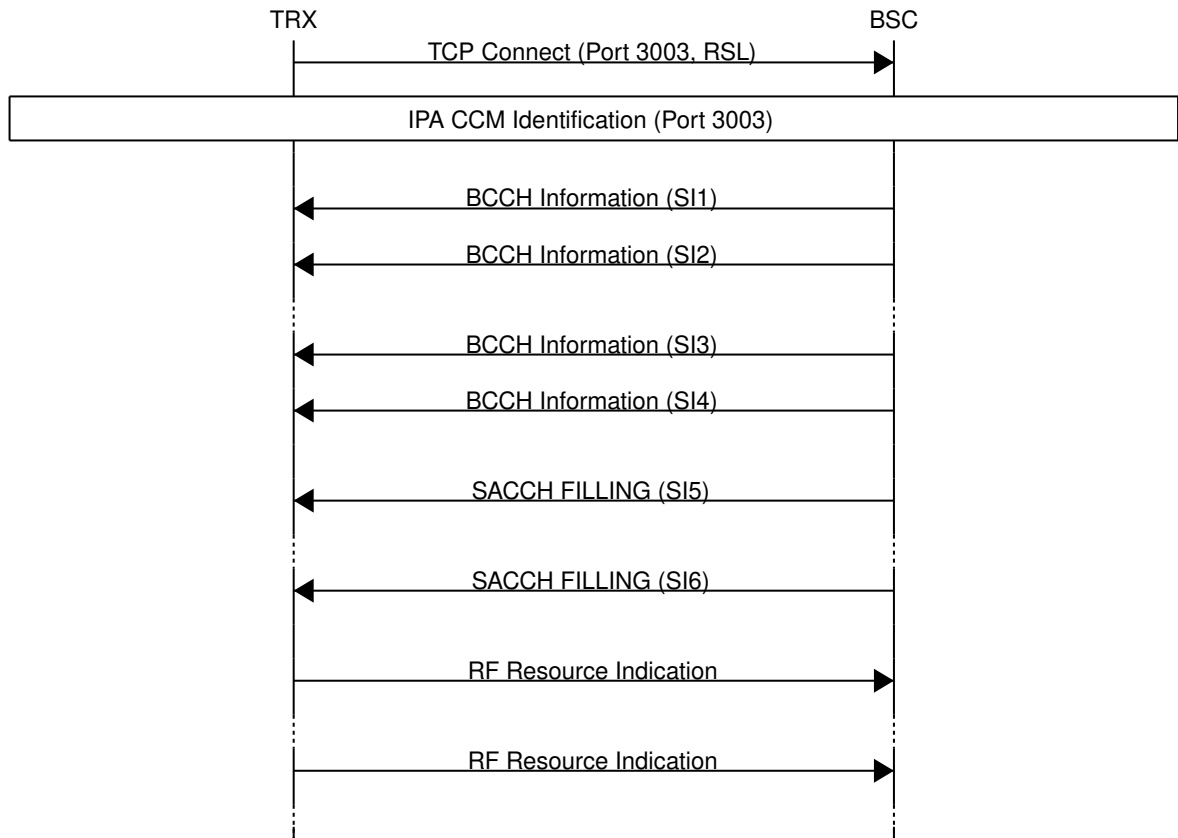

Figure 14: A-bis RSL BTS bring-up for primary TRX

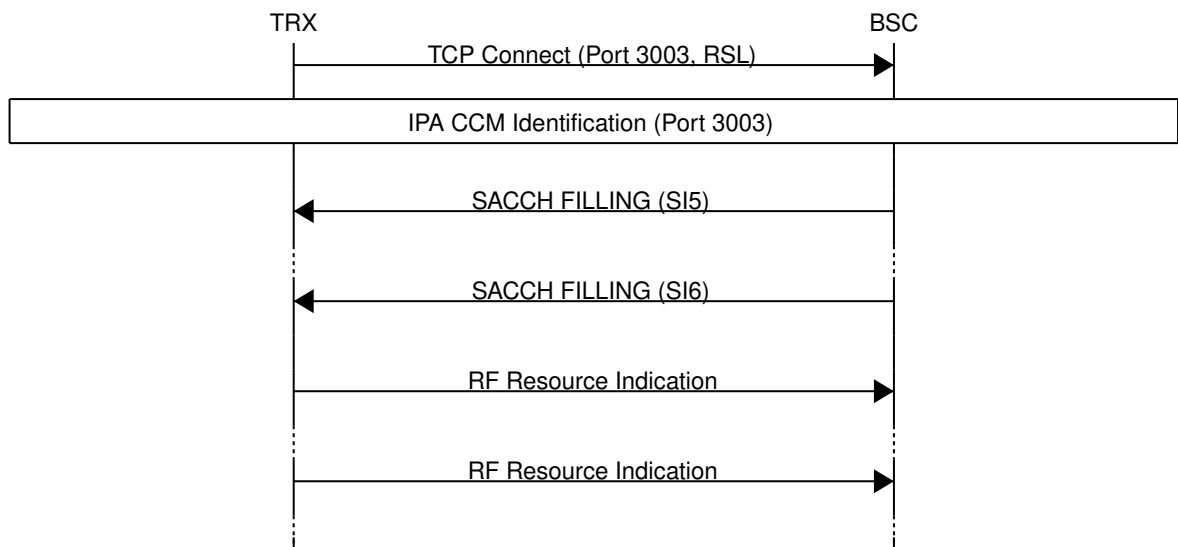

Figure 15: A-bis RSL BTS bring-up for secondary TRXs

The initialization of the primary and secondary TRX slightly differ, as illustrated by the differences of Figure 14 and Figure 15. Since the secondary TRX has no BCCH, it does not (need to) receive any *RSL BCCH INFORMATION* messages from the BSC.

6 User-Plane Traffic via RTP

RTP (Realtime Transfer Protocol) is a protocol for streaming audio and video data. It is specified by IETF RFC 1889.

OsmoBTS A-bis/IP implements RTP as transport medium for circuit-switched user-plane traffic, contrary to the E1 sub-slot based transport specified in 3GPP TS 08.60.

The RTP transport endpoint parameters are configured using the RSL User Plane Transport Management procedures described in Section 5.3.

RTCP is implemented in addition to RTP, on a UDP port number of the RTP port incremented by one.

6.1 RTP Payload Formats

The RTP payload format depends on the voice codec used on the radio channel. The OsmoBTS is simply passing the GSM speech frames between the Um radio interface channels and the RTP payload (and vice-versa).

No transcoding function is implemented in the BTS!

Table 48: RTP Payload formats

TCH	Codec	RTP payload format specification
TCH/F	FR	IETF RFC 3551 Section 4.5.8
TCH/F	EFR	IETF RFC 3551 Section 4.5.9
TCH/F	AMR	IETF RFC 4867
TCH/H	HR	IETF RFC 5993
TCH/H	AMR	IETF RFC 4867

7 Glossary

2FF

2nd Generation Form Factor; the so-called plug-in SIM form factor

3FF

3rd Generation Form Factor; the so-called microSIM form factor

3GPP

3rd Generation Partnership Project

4FF

4th Generation Form Factor; the so-called nanoSIM form factor

A Interface

Interface between BTS and BSC, traditionally over E1 (3GPP TS 48.008 [3gpp-ts-48-008])

A3/A8

Algorithm 3 and 8; Authentication and key generation algorithm in GSM and GPRS, typically COMP128v1/v2/v3 or MILENAGE are typically used

A5

Algorithm 5; Air-interface encryption of GSM; currently only A5/0 (no encryption), A5/1 and A5/3 are in use

Abis Interface

Interface between BTS and BSC, traditionally over E1 (3GPP TS 48.058 [3gpp-ts-48-058] and 3GPP TS 52.021 [3gpp-ts-52-021])

ACC

Access Control Class; every BTS broadcasts a bit-mask of permitted ACC, and only subscribers with a SIM of matching ACC are permitted to use that BTS

AGCH

Access Grant Channel on Um interface; used to assign a dedicated channel in response to RACH request

AGPL

GNU Affero General Public License, a copyleft-style Free Software License

AQPSK

Adaptive QPSK, a modulation scheme used by VAMOS channels on Downlink

ARFCN

Absolute Radio Frequency Channel Number; specifies a tuple of uplink and downlink frequencies

AUC

Authentication Center; central database of authentication key material for each subscriber

BCCH

Broadcast Control Channel on Um interface; used to broadcast information about Cell and its neighbors

BCC

Base Station Color Code; short identifier of BTS, lower part of BSIC

BTS

Base Transceiver Station

BSC

Base Station Controller

BSIC

Base Station Identity Code; 16bit identifier of BTS within location area

BSSGP

Base Station Subsystem Gateway Protocol (*3GPP TS 48.018* [[3gpp-ts-48-018](#)])

BVCI

BSSGP Virtual Circuit Identifier

CBC

Cell Broadcast Centre; central entity of Cell Broadcast service

CBCH

Cell Broadcast Channel; used to transmit Cell Broadcast SMS (SMS-CB)

CBS

Cell Broadcast Service

CBSP

Cell Broadcast Service Protocol (*3GPP TS 48.049* [[3gpp-ts-48-049](#)])

CC

Call Control; Part of the GSM Layer 3 Protocol

CCCH

Common Control Channel on Um interface; consists of RACH (uplink), BCCH, PCH, AGCH (all downlink)

Cell

A cell in a cellular network, served by a BTS

CEPT

Conférence européenne des administrations des postes et des télécommunications; European Conference of Postal and Telecommunications Administrations.

CGI

Cell Global Identifier comprised of MCC, MNC, LAC and BSIC

CSFB

Circuit-Switched Fall Back; Mechanism for switching from LTE/EUTRAN to UTRAN/GERAN when circuit-switched services such as voice telephony are required.

dB

deci-Bel; relative logarithmic unit

dBm

deci-Bel (milliwatt); unit of measurement for signal strength of radio signals

DHCP

Dynamic Host Configuration Protocol (*IETF RFC 2131* [[ietf-rfc2131](#)])

downlink

Direction of messages / signals from the network core towards the mobile phone

DSCP

Differentiated Services Code Point (*IETF RFC 2474* [[ietf-rfc2474](#)])

DSP

Digital Signal Processor

dnxload

Tool to program UBL and the Bootloader on a sysmoBTS

EDGE

Enhanced Data rates for GPRS Evolution; Higher-speed improvement of GPRS; introduces 8PSK

EGPRS

Enhanced GPRS; the part of EDGE relating to GPRS services

EIR

Equipment Identity Register; core network element that stores and manages IMEI numbers

ESME

External SMS Entity; an external application interfacing with a SMSC over SMPP

ETSI

European Telecommunications Standardization Institute

FPGA

Field Programmable Gate Array; programmable digital logic hardware

Gb

Interface between PCU and SGSN in GPRS/EDGE network; uses NS, BSSGP, LLC

GERAN

GPRS/EDGE Radio Access Network

GFDL

GNU Free Documentation License; a copyleft-style Documentation License

GGSN

GPRS Gateway Support Node; gateway between GPRS and external (IP) network

GMSK

Gaussian Minimum Shift Keying; modulation used for GSM and GPRS

GPL

GNU General Public License, a copyleft-style Free Software License

Gp

Gp interface between SGSN and GGSN; uses GTP protocol

GPRS

General Packet Radio Service; the packet switched 2G technology

GPS

Global Positioning System; provides a highly accurate clock reference besides the global position

GSM

Global System for Mobile Communications. ETSI/3GPP Standard of a 2G digital cellular network

GSMTAP

GSM tap; pseudo standard for encapsulating GSM protocol layers over UDP/IP for analysis

GSUP

Generic Subscriber Update Protocol. Osmocom-specific alternative to TCAP/MAP

GT

Global Title; an address in SCCP

GTP

GPRS Tunnel Protocol; used between SGSN and GGSN

HLR

Home Location Register; central subscriber database of a GSM network

HNB-GW

Home NodeB Gateway. Entity between femtocells (Home NodeB) and CN in 3G/UMTS.

HPLMN

Home PLMN; the network that has issued the subscriber SIM and has his record in HLR

IE

Information Element

IMEI

International Mobile Equipment Identity; unique 14-digit decimal number to globally identify a mobile device, optionally with a 15th checksum digit

IMEISV

IMEI software version; unique 14-digit decimal number to globally identify a mobile device (same as IMEI) plus two software version digits (total digits: 16)

IMSI

International Mobile Subscriber Identity; 15-digit unique identifier for the subscriber/SIM; starts with MCC/MNC of issuing operator

IP

Internet Protocol (*IETF RFC 791* [[ietf-rfc791](#)])

IPA

ip.access GSM over IP protocol; used to multiplex a single TCP connection

Iu

Interface in 3G/UMTS between RAN and CN

IuCS

Iu interface for circuit-switched domain. Used in 3G/UMTS between RAN and MSC

IuPS

Iu interface for packet-switched domain. Used in 3G/UMTS between RAN and SGSN

LAC

Location Area Code; 16bit identifier of Location Area within network

LAPD

Link Access Protocol, D-Channel (*ITU-T Q.921* [[itu-t-q921](#)])

LAPDm

Link Access Protocol Mobile (*3GPP TS 44.006* [[3gpp-ts-44-006](#)])

LLC

Logical Link Control; GPRS protocol between MS and SGSN (*3GPP TS 44.064* [[3gpp-ts-44-064](#)])

Location Area

Location Area; a geographic area containing multiple BTS

LU

Location Updating; can be of type IMSI-Attach or Periodic. Procedure that indicates a subscriber's physical presence in a given radio cell.

M2PA

MTP2 Peer-to-Peer Adaptation; a SIGTRAN Variant (*RFC 4165* [[ietf-rfc4165](#)])

M2UA

MTP2 User Adaptation; a SIGTRAN Variant (*RFC 3331* [[ietf-rfc3331](#)])

M3UA

MTP3 User Adaptation; a SIGTRAN Variant (*RFC 4666* [[ietf-rfc4666](#)])

MCC

Mobile Country Code; unique identifier of a country, e.g. 262 for Germany

MF

Machine-to-Machine Form Factor; a SIM chip package that is soldered permanently onto M2M device circuit boards.

MGW

Media Gateway

MM

Mobility Management; part of the GSM Layer 3 Protocol

MNC

Mobile Network Code; identifies network within a country; assigned by national regulator

MNCC

Mobile Network Call Control; Unix domain socket based Interface between MSC and external call control entity like osmo-sip-connector

MNO

Mobile Network Operator; operator with physical radio network under his MCC/MNC

MO

Mobile Originated. Direction from Mobile (MS/UE) to Network

MS

Mobile Station; a mobile phone / GSM Modem

MSC

Mobile Switching Center; network element in the circuit-switched core network

MSC pool

A number of redundant MSCs serving the same core network, which a BSC / RNC distributes load across; see also the "MSC Pooling" chapter in OsmoBSC's user manual [[userman-osmobsc](#)] and *3GPP TS 23.236* [[3gpp-ts-23-236](#)]

MSISDN

Mobile Subscriber ISDN Number; telephone number of the subscriber

MT

Mobile Terminated. Direction from Network to Mobile (MS/UE)

MTP

Message Transfer Part; SS7 signaling protocol (*ITU-T Q.701* [[itu-t-q701](#)])

MVNO

Mobile Virtual Network Operator; Operator without physical radio network

NCC

Network Color Code; assigned by national regulator

NITB

Network In The Box; combines functionality traditionally provided by BSC, MSC, VLR, HLR, SMSC functions; see OsmoNITB

NRI

Network Resource Indicator, typically 10 bits of a TMSI indicating which MSC of an MSC pool attached the subscriber; see also the "MSC Pooling" chapter in OsmoBSC's user manual [[userman-osmobsc](#)] and *3GPP TS 23.236* [[3gpp-ts-23-236](#)]

NSEI

NS Entity Identifier

NVCI

NS Virtual Circuit Identifier

NWL

Network Listen; ability of some BTS to receive downlink from other BTSs

NS

Network Service; protocol on Gb interface (*3GPP TS 48.016* [[3gpp-ts-48-016](#)])

OCXO

Oven Controlled Crystal Oscillator; very high precision oscillator, superior to a VCTCXO

OML

Operation & Maintenance Link (*ETSI/3GPP TS 52.021* [[3gpp-ts-52-021](#)])

OpenBSC

Open Source implementation of GSM network elements, specifically OsmoBSC, OsmoNITB, OsmoSGSN

OpenGGSN

Open Source implementation of a GPRS Packet Control Unit

OpenVPN

Open-Source Virtual Private Network; software employed to establish encrypted private networks over untrusted public networks

Osmocom

Open Source MOBILE COMMunications; collaborative community for implementing communications protocols and systems, including GSM, GPRS, TETRA, DECT, GMR and others

OsmoBSC

Open Source implementation of a GSM Base Station Controller

OsmoNITB

Open Source implementation of a GSM Network In The Box, combines functionality traditionally provided by BSC, MSC, VLR, HLR, AUC, SMSC

OsmoSGSN

Open Source implementation of a Serving GPRS Support Node

OsmoPCU

Open Source implementation of a GPRS Packet Control Unit

OTA

Over-The-Air; Capability of operators to remotely reconfigure/reprogram ISM/USIM cards

PC

Point Code; an address in MTP

PCH

Paging Channel on downlink Um interface; used by network to page an MS

PCP

Priority Code Point (*IEEE 802.1Q* [?])

PCU

Packet Control Unit; used to manage Layer 2 of the GPRS radio interface

PDCH

Packet Data Channel on Um interface; used for GPRS/EDGE signalling + user data

PIN

Personal Identification Number; a number by which the user authenticates to a SIM/USIM or other smart card

PLMN

Public Land Mobile Network; specification language for a single GSM network

PUK

PIN Unblocking Code; used to unblock a blocked PIN (after too many wrong PIN attempts)

RAC

Routing Area Code; 16bit identifier for a Routing Area within a Location Area

RACH

Random Access Channel on uplink Um interface; used by MS to request establishment of a dedicated channel

RAM

Remote Application Management; Ability to remotely manage (install, remove) Java Applications on SIM/USIM Card

RF

Radio Frequency

RFM

Remote File Management; Ability to remotely manage (write, read) files on a SIM/USIM card

Roaming

Procedure in which a subscriber of one network is using the radio network of another network, often in different countries; in some countries national roaming exists

Routing Area

Routing Area; GPRS specific sub-division of Location Area

RR

Radio Resources; Part of the GSM Layer 3 Protocol

RSL

Radio Signalling Link (*3GPP TS 48.058* [[3gpp-ts-48-058](#)])

RTP

Real-Time Transport Protocol (*IETF RFC 3550* [[ietf-rfc3550](#)]); Used to transport audio/video streams over UDP/IP

SACCH

Slow Associate Control Channel on Um interface; bundled to a TCH or SDCCH, used for signalling in parallel to active dedicated channel

SCCP

Signaling Connection Control Part; SS7 signaling protocol (*ITU-T Q.711* [[itu-t-q711](#)])

SDCCH

Slow Dedicated Control Channel on Um interface; used for signalling and SMS transport in GSM

SDK

Software Development Kit

SGs

Interface between MSC (GSM/UMTS) and MME (LTE/EPC) to facilitate CSFB and SMS.

SGSN

Serving GPRS Support Node; Core network element for packet-switched services in GSM and UMTS.

SIGTRAN

Signaling Transport over IP (*IETF RFC 2719* [[ietf-rfc2719](#)])

SIM

Subscriber Identity Module; small chip card storing subscriber identity

Site

A site is a location where one or more BTSs are installed, typically three BTSs for three sectors

SMPP

Short Message Peer-to-Peer; TCP based protocol to interface external entities with an SMSC

SMSC

Short Message Service Center; store-and-forward relay for short messages

SS7

Signaling System No. 7; Classic digital telephony signaling system

SS

Supplementary Services; query and set various service parameters between subscriber and core network (e.g. USSD, 3rd-party calls, hold/retrieve, advice-of-charge, call deflection)

SSH

Secure Shell; *IETF RFC 4250* [[ietf-rfc4251](#)] to 4254

SSN

Sub-System Number; identifies a given SCCP Service such as MSC, HLR

STP

Signaling Transfer Point; A Router in SS7 Networks

SUA

SCCP User Adaptation; a SIGTRAN Variant (*RFC 3868* [[ietf-rfc3868](#)])

syslog

System logging service of UNIX-like operating systems

System Information

A set of downlink messages on the BCCH and SACCH of the Um interface describing properties of the cell and network

TCH

Traffic Channel; used for circuit-switched user traffic (mostly voice) in GSM

TCP

Transmission Control Protocol; (*IETF RFC 793* [[ietf-rfc793](#)])

TFTP

Trivial File Transfer Protocol; (*IETF RFC 1350* [[ietf-rfc1350](#)])

TOS

Type Of Service; bit-field in IPv4 header, now re-used as DSCP (*IETF RFC 791* [[ietf-rfc791](#)])

TRX

Transceiver; element of a BTS serving a single carrier

TS

Technical Specification

u-Boot

Boot loader used in various embedded systems

UBI

An MTD wear leveling system to deal with NAND flash in Linux

UBL

Initial bootloader loaded by the TI Davinci SoC

UDP

User Datagram Protocol (*IETF RFC 768* [[ietf-rfc768](#)])

UICC

Universal Integrated Chip Card; A smart card according to *ETSI TR 102 216* [[etsi-tr102216](#)]

Um interface

U mobile; Radio interface between MS and BTS

uplink

Direction of messages: Signals from the mobile phone towards the network

USIM

Universal Subscriber Identity Module; application running on a UICC to provide subscriber identity for UMTS and GSM networks

USSD

Unstructured Supplementary Service Data; textual dialog between subscriber and core network, e.g. **100 → Your extension is 1234*

VAMOS

Voice services over Adaptive Multi-user channels on One Slot; an optional extension for GSM specified in Release 9 of 3GPP GERAN specifications (*3GPP TS 48.018* [[3gpp-ts-48-018](#)]) allowing two independent UEs to transmit and receive simultaneously on traffic channels

VCTCXO

Voltage Controlled, Temperature Compensated Crystal Oscillator; a precision oscillator, superior to a classic crystal oscillator, but inferior to an OCXO

VLAN

Virtual LAN in the context of Ethernet (*IEEE 802.1Q* [[ieee-802.1q](#)])

VLR

Visitor Location Register; volatile storage of attached subscribers in the MSC

VPLMN

Visited PLMN; the network in which the subscriber is currently registered; may differ from HPLMN when on roaming

VTY

Virtual Teletype; a textual command-line interface for configuration and introspection, e.g. the OsmoBSC configuration file as well as its telnet link on port 4242

A Osmocom TCP/UDP Port Numbers

The Osmocom GSM system utilizes a variety of TCP/IP based protocols. The table below provides a reference as to which port numbers are used by which protocol / interface.

Table 49: TCP/UDP port numbers

L4 Protocol	Port Number	Purpose	Software
UDP	1984	Osmux	osmo-mgw, osmo-bts
UDP	2427	MGCP GW	osmo-bsc_mgcp, osmo-mgw
TCP	2775	SMPP (SMS interface for external programs)	osmo-nitb
TCP	3002	A-bis/IP OML	osmo-bts, osmo-bsc, osmo-nitb
TCP	3003	A-bis/IP RSL	osmo-bts, osmo-bsc, osmo-nitb
TCP	4227	telnet (VTY)	osmo-pcap-client
TCP	4228	telnet (VTY)	osmo-pcap-server
TCP	4236	Control Interface	osmo-trx
TCP	4237	telnet (VTY)	osmo-trx
TCP	4238	Control Interface	osmo-bts
TCP	4239	telnet (VTY)	osmo-stp
TCP	4240	telnet (VTY)	osmo-pcu
TCP	4241	telnet (VTY)	osmo-bts
TCP	4242	telnet (VTY)	osmo-nitb, osmo-bsc, cellmgr-ng
TCP	4243	telnet (VTY)	osmo-bsc_mgcp, osmo-mgw
TCP	4244	telnet (VTY)	osmo-bsc_nat
TCP	4245	telnet (VTY)	osmo-sgsn
TCP	4246	telnet (VTY)	osmo-gbproxy
TCP	4247	telnet (VTY)	OsmocomBB
TCP	4249	Control Interface	osmo-nitb, osmo-bsc
TCP	4250	Control Interface	osmo-bsc_nat
TCP	4251	Control Interface	osmo-sgsn
TCP	4252	telnet (VTY)	sysmobts-mgr
TCP	4253	telnet (VTY)	osmo-gtphub
TCP	4254	telnet (VTY)	osmo-msc
TCP	4255	Control Interface	osmo-msc
TCP	4256	telnet (VTY)	osmo-sip-connector
TCP	4257	Control Interface	osmo-ggsn, ggsn (OpenGGSN)
TCP	4258	telnet (VTY)	osmo-hlr
TCP	4259	Control Interface	osmo-hlr
TCP	4260	telnet (VTY)	osmo-ggsn
TCP	4261	telnet (VTY)	osmo-hnbgw
TCP	4262	Control Interface	osmo-hnbgw
TCP	4263	Control Interface	osmo-gbproxy
TCP	4264	telnet (VTY)	osmo-cbc
TCP	4265	Control Interface	osmo-cbc
TCP	4266	D-GSM MS Lookup: mDNS serve	osmo-hlr
TCP	4267	Control Interface	osmo-mgw
TCP	4268	telnet (VTY)	osmo-uecups
SCTP	4268	UECUPS	osmo-uecups
TCP	4269	telnet (VTY)	osmo-e1d
TCP	4270	telnet (VTY)	osmo-isdntap
TCP	4271	telnet (VTY)	osmo-smlc
TCP	4272	Control Interface	osmo-smlc
TCP	4273	telnet (VTY)	osmo-hnodeb
TCP	4274	Control Interface	osmo-hnodeb

Table 49: (continued)

L4 Protocol	Port Number	Purpose	Software
TCP	4275	telnet (VTY)	osmo-upf
TCP	4276	Control Interface	osmo-upf
TCP	4277	telnet (VTY)	osmo-pfcp-tool
TCP	4278	Control Interface	osmo-pfcp-tool
UDP	4729	GSMTAP	Almost every osmocom project
TCP	5000	A/IP	osmo-bsc, osmo-bsc_nat
UDP	23000	GPRS-NS over IP default port	osmo-pcu, osmo-sgsn, osmo-gbproxy
TCP	48049	BSC-CBC (CBSP) default port	osmo-bsc, osmo-cbc

B Bibliography / References

B.0.0.0.1 References

- [1] [userman-ice1usb] Osmocom Project: icE1usb User Manual.
- [2] [userman-ogt] Pau Espin: osmo-gsm-tester User Manual.
- [3] [userman-remsim] Harald Welte: osmo-remsim User Manual.
- [4] [osmobts-abis-spec] Neels Hofmeyr & Harald Welte. OsmoBTS Abis Protocol Specification. <https://ftp.osmocom.org/docs/latest/osmobts-abis.pdf>
- [5] [userman-osmobsc] Osmocom Project: OsmoBSC User Manual. <https://ftp.osmocom.org/docs/latest/osmobsc-usermanual.pdf>
- [6] [vty-ref-osmobsc] Osmocom Project: OsmoBSC VTY Reference Manual. <https://ftp.osmocom.org/docs/latest/osmobsc-vty-reference.pdf>
- [7] [userman-osmobts] Osmocom Project: OsmoBTS User Manual. <https://ftp.osmocom.org/docs/latest/osmobts-usermanual.pdf>
- [8] [vty-ref-osmobts] Osmocom Project: OsmoBTS VTY Reference Manual. <https://ftp.osmocom.org/docs/latest/osmobts-trx-vty-reference.pdf> <https://ftp.osmocom.org/docs/latest/osmobts-sysmo-vty-reference.pdf> <https://ftp.osmocom.org/docs/latest/osmobts-lc15-vty-reference.pdf> <https://ftp.osmocom.org/docs/latest/osmobts-oc2g-vty-reference.pdf> <https://ftp.osmocom.org/docs/latest/osmobts-octphy-vty-reference.pdf> <https://ftp.osmocom.org/docs/latest/osmobts-virtual-vty-reference.pdf>
- [9] [userman-osmocbc] Osmocom Project: OsmoCBC User Manual. <https://ftp.osmocom.org/docs/latest/osmocbc-usermanual.pdf>
- [10] [vty-ref-osmocbc] Osmocom Project: OsmoCBC VTY Reference Manual. <https://ftp.osmocom.org/docs/latest/osmocbc-vty-reference.pdf>
- [11] [userman-osmogbproxy] Osmocom Project: OsmoGBProxy User Manual. <https://ftp.osmocom.org/docs/latest/osmogbproxy-usermanual.pdf>
- [12] [vty-ref-osmogbproxy] Osmocom Project: OsmoGBProxy VTY Reference Manual. <https://ftp.osmocom.org/docs/latest/osmogbproxy-vty-reference.pdf>
- [13] [userman-osmoggsn] Osmocom Project: OpenGGSN User Manual. <https://ftp.osmocom.org/docs/latest/osmoggsn-usermanual.pdf>
- [14] [vty-ref-osmoggsn] Osmocom Project: OsmoGGSN VTY Reference Manual. <https://ftp.osmocom.org/docs/latest/osmoggsn-vty-reference.pdf>

- [15] [userman-osmohlr] Osmocom Project: OsmoHLR User Manual. <https://ftp.osmocom.org/docs/latest/osmohlr-usermanual.pdf>
- [16] [vty-ref-osmohlr] Osmocom Project: OsmoHLR VTY Reference Manual. <https://ftp.osmocom.org/docs/latest/osmohlr-vty-reference.pdf>
- [17] [userman-osmohnbgw] Osmocom Project: OsmoHNBGW User Manual. <https://ftp.osmocom.org/docs/latest/osmohnbgw-usermanual.pdf>
- [18] [vty-ref-osmohnbgw] Osmocom Project: OsmoHNBGW VTY Reference Manual. <https://ftp.osmocom.org/docs/latest/osmohnbgw-vty-reference.pdf>
- [19] [userman-osmomgw] Osmocom Project: OsmoMGW User Manual. <https://ftp.osmocom.org/docs/latest/osmomgw-usermanual.pdf>
- [20] [vty-ref-osmomgw] Osmocom Project: OsmoMGW VTY Reference Manual. <https://ftp.osmocom.org/docs/latest/osmomgw-vty-reference.pdf>
- [21] [userman-osmomsc] Osmocom Project: OsmoMSC User Manual. <https://ftp.osmocom.org/docs/latest/osmomsc-usermanual.pdf>
- [22] [vty-ref-osmomsc] Osmocom Project: OsmoMSC VTY Reference Manual. <https://ftp.osmocom.org/docs/latest/osmomsc-vty-reference.pdf>
- [23] [userman-osmonitb] Osmocom Project: OsmoNITB User Manual. <https://ftp.osmocom.org/docs/latest/osmonitb-usermanual.pdf>
- [24] [vty-ref-osmonitb] Osmocom Project: OsmoNITB VTY Reference Manual. <https://ftp.osmocom.org/docs/latest/osmonitb-vty-reference.pdf>
- [25] [userman-osmopcu] Osmocom Project: OsmoPCU User Manual. <https://ftp.osmocom.org/docs/latest/osmopcu-usermanual.pdf>
- [26] [vty-ref-osmopcu] Osmocom Project: OsmoPCU VTY Reference Manual. <https://ftp.osmocom.org/docs/latest/osmopcu-vty-reference.pdf>
- [27] [userman-osmosgsn] Osmocom Project: OsmoSGSN User Manual. <https://ftp.osmocom.org/docs/latest/osmosgsn-usermanual.pdf>
- [28] [vty-ref-osmosgsn] Osmocom Project: OsmoSGSN VTY Reference Manual. <https://ftp.osmocom.org/docs/latest/osmosgsn-vty-reference.pdf>
- [29] [userman-osmosipconnector] Osmocom Project: OsmoSIPconnector User Manual. <https://ftp.osmocom.org/docs/latest/osmosipconnector-usermanual.pdf>
- [30] [vty-ref-osmosipconnector] Osmocom Project: OsmoSIPconnector VTY Reference Manual. <https://ftp.osmocom.org/docs/latest/osmosipconnector-vty-reference.pdf>
- [31] [userman-osmosmlc] Osmocom Project: OsmoSMLC User Manual. <https://ftp.osmocom.org/docs/latest/osmosmlc-usermanual.pdf>
- [32] [vty-ref-osmosmlc] Osmocom Project: OsmoSMLC VTY Reference Manual. <https://ftp.osmocom.org/docs/latest/osmosmlc-vty-reference.pdf>
- [33] [userman-osmostp] Osmocom Project: OsmoSTP User Manual. <https://ftp.osmocom.org/docs/latest/osmostp-usermanual.pdf>
- [34] [vty-ref-osmostp] Osmocom Project: OsmoSTP VTY Reference Manual. <https://ftp.osmocom.org/docs/latest/osmostp-vty-reference.pdf>
- [35] [userman-osmotrx] Osmocom Project: OsmoTRX User Manual. <https://ftp.osmocom.org/docs/latest/osmotrx-usermanual.pdf>

- [36] [vty-ref-osmotrx] Osmocom Project: OsmoTRX VTY Reference Manual. <https://ftp.osmocom.org/docs/latest/osmotrx-uhd-vty-reference.pdf> <https://ftp.osmocom.org/docs/latest/osmotrx-lms-vty-reference.pdf> <https://ftp.osmocom.org/docs/latest/osmotrx-ipc-vty-reference.pdf> <https://ftp.osmocom.org/docs/latest/osmotrx-usrp1-vty-reference.pdf>
- [37] [3gpp-ts-23-041] 3GPP TS 23.041: Technical realization of Cell Broadcast Service (CBS)
- [38] [3gpp-ts-23-048] 3GPP TS 23.048: Security mechanisms for the (U)SIM application toolkit; Stage 2 <https://www.3gpp.org/DynaReport/23048.htm>
- [39] [3gpp-ts-23-236] 3GPP TS 23.236: Intra-domain connection of Radio Access Network (RAN) nodes to multiple Core Network (CN) nodes <https://www.3gpp.org/DynaReport/23236.htm>
- [40] [3gpp-ts-24-007] 3GPP TS 24.007: Mobile radio interface signalling layer 3; General Aspects <https://www.3gpp.org/DynaReport/24007.htm>
- [41] [3gpp-ts-24-008] 3GPP TS 24.008: Mobile radio interface Layer 3 specification; Core network protocols; Stage 3. <https://www.3gpp.org/dynareport/24008.htm>
- [42] [3gpp-ts-31-101] 3GPP TS 31.101: UICC-terminal interface; Physical and logical characteristics <https://www.3gpp.org/DynaReport/31101.htm>
- [43] [3gpp-ts-31-102] 3GPP TS 31.102: Characteristics of the Universal Subscriber Identity Module (USIM) application <https://www.3gpp.org/DynaReport/31102.htm>
- [44] [3gpp-ts-31-103] 3GPP TS 31.103: Characteristics of the IMS Subscriber Identity Module (ISIM) application <https://www.3gpp.org/DynaReport/31103.htm>
- [45] [3gpp-ts-31-111] 3GPP TS 31.111: Universal Subscriber Identity Module (USIM) Application Toolkit (USAT) <https://www.3gpp.org/DynaReport/31111.htm>
- [46] [3gpp-ts-31-115] 3GPP TS 31.115: Secured packet structure for (Universal) Subscriber Identity Module (U)SIM Toolkit applications <https://www.3gpp.org/DynaReport/31115.htm>
- [47] [3gpp-ts-31-116] 3GPP TS 31.116: Remote APDU Structure for (U)SIM Toolkit applications <https://www.3gpp.org/DynaReport/31116.htm>
- [48] [3gpp-ts-35-205] 3GPP TS 35.205: 3G Security; Specification of the MILENAGE algorithm set: General
- [49] [3gpp-ts-35-206] 3GPP TS 35.206: 3G Security; Specification of the MILENAGE algorithm set: Algorithm specification <https://www.3gpp.org/DynaReport/35206.htm>
- [50] [3gpp-ts-44-006] 3GPP TS 44.006: Mobile Station - Base Station System (MS - BSS) interface; Data Link (DL) layer specification <https://www.3gpp.org/DynaReport/44006.htm>
- [51] [3gpp-ts-44-018] 3GPP TS 44.018: Mobile radio interface layer 3 specification; Radio Resource Control (RRC) protocol <https://www.3gpp.org/DynaReport/44018.htm>
- [52] [3gpp-ts-44-064] 3GPP TS 44.064: Mobile Station - Serving GPRS Support Node (MS-SGSN); Logical Link Control (LLC) Layer Specification <https://www.3gpp.org/DynaReport/44064.htm>
- [53] [3gpp-ts-45-002] 3GPP TS 45.002: Digital cellular telecommunications system (Phase 2+) (GSM); GSM/EDGE Multiplexing and multiple access on the radio path <https://www.3gpp.org/DynaReport/45002.htm>
- [54] [3gpp-ts-48-008] 3GPP TS 48.008: Mobile Switching Centre - Base Station system (MSC-BSS) interface; Layer 3 specification <https://www.3gpp.org/DynaReport/48008.htm>
- [55] [3gpp-ts-48-016] 3GPP TS 48.016: General Packet Radio Service (GPRS); Base Station System (BSS) - Serving GPRS Support Node (SGSN) interface; Network service <https://www.3gpp.org/DynaReport/48016.htm>
- [56] [3gpp-ts-48-018] 3GPP TS 48.018: General Packet Radio Service (GPRS); Base Station System (BSS) - Serving GPRS Support Node (SGSN); BSS GPRS protocol (BSSGP) <https://www.3gpp.org/DynaReport/48018.htm>

- [57] [3gpp-ts-48-049] 3GPP TS 48.049: Digital cellular communications system; Base Station Controller - Cell Broadcast Centre (BSC-CBC) interface specification; Cell Broadcast Service Protocol (CBSP) <https://www.3gpp.org/DynaReport/48049.htm>
- [58] [3gpp-ts-48-056] 3GPP TS 48.056: Base Station Controller - Base Transceiver Station (BSC - BTS) interface; Layer 2 specification <https://www.3gpp.org/DynaReport/48056.htm>
- [59] [3gpp-ts-48-058] 3GPP TS 48.058: Base Station Controller - Base Transceiver Station (BSC - BTS) Interface; Layer 3 specification <https://www.3gpp.org/DynaReport/48058.htm>
- [60] [3gpp-ts-51-011] 3GPP TS 51.011: Specification of the Subscriber Identity Module - Mobile Equipment (SIM-ME) interface
- [61] [3gpp-ts-51-014] 3GPP TS 51.014: Specification of the SIM Application Toolkit for the Subscriber Identity Module - Mobile Equipment (SIM - ME) interface <https://www.3gpp.org/DynaReport/51014.htm>
- [62] [3gpp-ts-52-021] 3GPP TS 52.021: Network Management (NM) procedures and messages on the A-bis interface <https://www.3gpp.org/DynaReport/52021.htm>
- [63] [etsi-tr102216] ETSI TR 102 216: Smart cards https://www.etsi.org/deliver/etsi_tr/102200_102299/102216/-03.00.00_60/tr_102216v030000p.pdf
- [64] [etsi-ts102221] ETSI TS 102 221: Smart Cards; UICC-Terminal interface; Physical and logical characteristics https://www.etsi.org/deliver/etsi_ts/102200_102299/102221/13.01.00_60/ts_102221v130100p.pdf
- [65] [etsi-ts101220] ETSI TS 101 220: Smart Cards; ETSI numbering system for telecommunication application providers https://www.etsi.org/deliver/etsi_ts/101200_101299/101220/12.00.00_60/ts_101220v120000p.pdf
- [66] [ieee-802.1q] IEEE 802.1Q: Bridges and Bridged Networks <https://ieeexplore.ieee.org/document/6991462>
- [67] [ietf-rfc768] IETF RFC 768: User Datagram Protocol <https://tools.ietf.org/html/rfc768>
- [68] [ietf-rfc791] IETF RFC 791: Internet Protocol <https://tools.ietf.org/html/rfc791>
- [69] [ietf-rfc793] IETF RFC 793: Transmission Control Protocol <https://tools.ietf.org/html/rfc793>
- [70] [ietf-rfc1035] IETF RFC 1035: Domain Names - Implementation and Specification <https://tools.ietf.org/html/rfc1035>
- [71] [ietf-rfc1350] IETF RFC 1350: Trivial File Transfer Protocol <https://tools.ietf.org/html/rfc1350>
- [72] [ietf-rfc2131] IETF RFC 2131: Dynamic Host Configuration Protocol <https://tools.ietf.org/html/rfc2131>
- [73] [ietf-rfc2474] IETF RFC 2474: Definition of the Differentiated Services Field (DS Field) in the IPv4 and IPv6 Headers <https://tools.ietf.org/html/rfc2474>
- [74] [ietf-rfc2719] IETF RFC 2719: Signal Transport over IP <https://tools.ietf.org/html/rfc2719>
- [75] [ietf-rfc3331] IETF RFC 3331: Message Transfer Part 2 User Adaptation Layer <https://tools.ietf.org/html/rfc3331>
- [76] [ietf-rfc3550] IETF RFC 3550: RTP: A Transport protocol for Real-Time Applications <https://tools.ietf.org/html/rfc3550>
- [77] [ietf-rfc3596] IETF RFC 3596: DNS Extensions to Support IP Version 6 <https://tools.ietf.org/html/rfc3596>
- [78] [ietf-rfc3868] IETF RFC 3868: SCCP User Adaptation Layer <https://tools.ietf.org/html/rfc3868>
- [79] [ietf-rfc4165] IETF RFC 4165: Message Transfer Part 2 Peer-to-Peer Adaptation Layer <https://tools.ietf.org/html/rfc4165>
- [80] [ietf-rfc4251] IETF RFC 4251: The Secure Shell (SSH) Protocol Architecture <https://tools.ietf.org/html/rfc4251>
- [81] [ietf-rfc4666] IETF RFC 4666: Message Transfer Part 3 User Adaptation Layer <https://tools.ietf.org/html/rfc4666>

- [82] [ietf-rfc5771] IETF RFC 5771: IANA Guidelines for IPv4 Multicast Address Assignments <https://tools.ietf.org/html/rfc5771>
- [83] [itu-t-q701] ITU-T Q.701: Functional Description of the Message Transfer Part (MTP) <https://www.itu.int/rec/-T-REC-Q.701/en/>
- [84] [itu-t-q711] ITU-T Q.711: Functional Description of the Signalling Connection Control Part <https://www.itu.int/rec/T-REC-Q.711/en/>
- [85] [itu-t-q713] ITU-T Q.713: Signalling connection control part formats and codes <https://www.itu.int/rec/T-REC-Q.713/en/>
- [86] [itu-t-q714] ITU-T Q.714: Signalling connection control part procedures <https://www.itu.int/rec/T-REC-Q.714/en/>
- [87] [itu-t-q921] ITU-T Q.921: ISDN user-network interface - Data link layer specification <https://www.itu.int/rec/-T-REC-Q.921/en>
- [88] [smpp-34] SMPP Developers Forum. Short Message Peer-to-Peer Protocol Specification v3.4 https://docs.nimta.com/SMPP_v3_4_Issue1_2.pdf
- [89] [gnu-agplv3] Free Software Foundation. GNU Affero General Public License. <https://www.gnu.org/licenses/-agpl-3.0.en.html>
- [90] [freeswitch_pbx] FreeSWITCH SIP PBX <https://freeswitch.org>

C GNU Free Documentation License

Version 1.3, 3 November 2008

Copyright © 2000, 2001, 2002, 2007, 2008 Free Software Foundation, Inc. <http://fsf.org>

Everyone is permitted to copy and distribute verbatim copies of this license document, but changing it is not allowed.

C.1 PREAMBLE

The purpose of this License is to make a manual, textbook, or other functional and useful document “free” in the sense of freedom: to assure everyone the effective freedom to copy and redistribute it, with or without modifying it, either commercially or noncommercially. Secondly, this License preserves for the author and publisher a way to get credit for their work, while not being considered responsible for modifications made by others.

This License is a kind of “copyleft”, which means that derivative works of the document must themselves be free in the same sense. It complements the GNU General Public License, which is a copyleft license designed for free software.

We have designed this License in order to use it for manuals for free software, because free software needs free documentation: a free program should come with manuals providing the same freedoms that the software does. But this License is not limited to software manuals; it can be used for any textual work, regardless of subject matter or whether it is published as a printed book. We recommend this License principally for works whose purpose is instruction or reference.

C.2 APPLICABILITY AND DEFINITIONS

This License applies to any manual or other work, in any medium, that contains a notice placed by the copyright holder saying it can be distributed under the terms of this License. Such a notice grants a world-wide, royalty-free license, unlimited in duration, to use that work under the conditions stated herein. The “Document”, below, refers to any such manual or work. Any member of the public is a licensee, and is addressed as “you”. You accept the license if you copy, modify or distribute the work in a way requiring permission under copyright law.

A “Modified Version” of the Document means any work containing the Document or a portion of it, either copied verbatim, or with modifications and/or translated into another language.

A “Secondary Section” is a named appendix or a front-matter section of the Document that deals exclusively with the relationship of the publishers or authors of the Document to the Document’s overall subject (or to related matters) and contains nothing that

could fall directly within that overall subject. (Thus, if the Document is in part a textbook of mathematics, a [Secondary Section](#) may not explain any mathematics.) The relationship could be a matter of historical connection with the subject or with related matters, or of legal, commercial, philosophical, ethical or political position regarding them.

The “Invariant Sections” are certain [Secondary Section](#) whose titles are designated, as being those of [Invariant Sections](#), in the notice that says that the Document is released under this License. If a section does not fit the above definition of Secondary then it is not allowed to be designated as Invariant. The Document may contain zero [Invariant Sections](#). If the Document does not identify any Invariant Sections then there are none.

The “Cover Texts” are certain short passages of text that are listed, as Front-Cover Texts or Back-Cover Texts, in the notice that says that the Document is released under this License. A Front-Cover Text may be at most 5 words, and a Back-Cover Text may be at most 25 words.

A “Transparent” copy of the Document means a machine-readable copy, represented in a format whose specification is available to the general public, that is suitable for revising the document straightforwardly with generic text editors or (for images composed of pixels) generic paint programs or (for drawings) some widely available drawing editor, and that is suitable for input to text formatters or for automatic translation to a variety of formats suitable for input to text formatters. A copy made in an otherwise [Transparent](#) file format whose markup, or absence of markup, has been arranged to thwart or discourage subsequent modification by readers is not [Transparent](#). An image format is not [Transparent](#) if used for any substantial amount of text. A copy that is not [Transparent](#) is called “Opaque”.

Examples of suitable formats for [Transparent](#) copies include plain ASCII without markup, Texinfo input format, LaTeX input format, SGML or XML using a publicly available DTD, and standard-conforming simple HTML, PostScript or PDF designed for human modification. Examples of transparent image formats include PNG, XCF and JPG. Opaque formats include proprietary formats that can be read and edited only by proprietary word processors, SGML or XML for which the DTD and/or processing tools are not generally available, and the machine-generated HTML, PostScript or PDF produced by some word processors for output purposes only.

The “Title Page” means, for a printed book, the title page itself, plus such following pages as are needed to hold, legibly, the material this License requires to appear in the title page. For works in formats which do not have any title page as such, [Title Page](#) means the text near the most prominent appearance of the work’s title, preceding the beginning of the body of the text.

The “publisher” means any person or entity that distributes copies of the Document to the public.

A section “Entitled XYZ” means a named subunit of the Document whose title either is precisely XYZ or contains XYZ in parentheses following text that translates XYZ in another language. (Here XYZ stands for a specific section name mentioned below, such as “Acknowledgements”, “Dedications”, “Endorsements”, or “History”.) To “Preserve the Title” of such a section when you modify the Document means that it remains a section “Entitled XYZ” according to this definition.

The Document may include Warranty Disclaimers next to the notice which states that this License applies to the Document. These Warranty Disclaimers are considered to be included by reference in this License, but only as regards disclaiming warranties: any other implication that these Warranty Disclaimers may have is void and has no effect on the meaning of this License.

C.3 VERBATIM COPYING

You may copy and distribute the Document in any medium, either commercially or noncommercially, provided that this License, the copyright notices, and the license notice saying this License applies to the Document are reproduced in all copies, and that you add no other conditions whatsoever to those of this License. You may not use technical measures to obstruct or control the reading or further copying of the copies you make or distribute. However, you may accept compensation in exchange for copies. If you distribute a large enough number of copies you must also follow the conditions in section [Section C.4](#).

You may also lend copies, under the same conditions stated above, and you may publicly display copies.

C.4 COPYING IN QUANTITY

If you publish printed copies (or copies in media that commonly have printed covers) of the Document, numbering more than 100, and the Document’s license notice requires [Cover Texts](#), you must enclose the copies in covers that carry, clearly and legibly, all these Cover Texts: [Front-Cover Texts](#) on the front cover, and [Back-Cover Texts](#) on the back cover. Both covers must also clearly and legibly identify you as the publisher of these copies. The front cover must present the full title with all words of the title equally prominent and visible. You may add other material on the covers in addition. Copying with changes limited to the

covers, as long as they preserve the title of the Document and satisfy these conditions, can be treated as verbatim copying in other respects.

If the required texts for either cover are too voluminous to fit legibly, you should put the first ones listed (as many as fit reasonably) on the actual cover, and continue the rest onto adjacent pages.

If you publish or distribute Opaque copies of the Document numbering more than 100, you must either include a machine-readable [Transparent](#) copy along with each Opaque copy, or state in or with each Opaque copy a computer-network location from which the general network-using public has access to download using public-standard network protocols a complete [Transparent](#) copy of the Document, free of added material. If you use the latter option, you must take reasonably prudent steps, when you begin distribution of Opaque copies in quantity, to ensure that this [Transparent](#) copy will remain thus accessible at the stated location until at least one year after the last time you distribute an Opaque copy (directly or through your agents or retailers) of that edition to the public.

It is requested, but not required, that you contact the authors of the Document well before redistributing any large number of copies, to give them a chance to provide you with an updated version of the Document.

C.5 MODIFICATIONS

You may copy and distribute a [Modified Version](#) of the Document under the conditions of sections 2 and 3 above, provided that you release the [Modified Version](#) under precisely this License, with the [Modified Version](#) filling the role of the Document, thus licensing distribution and modification of the [Modified Version](#) to whoever possesses a copy of it. In addition, you must do these things in the [Modified Version](#):

- a. Use in the [Title Page](#) (and on the covers, if any) a title distinct from that of the Document, and from those of previous versions (which should, if there were any, be listed in the History section of the Document). You may use the same title as a previous version if the original publisher of that version gives permission.
- b. List on the [Title Page](#), as authors, one or more persons or entities responsible for authorship of the modifications in the [Modified Version](#), together with at least five of the principal authors of the Document (all of its principal authors, if it has fewer than five), unless they release you from this requirement.
- c. State on the [Title Page](#) the name of the publisher of the [Modified Version](#), as the publisher.
- d. Preserve all the copyright notices of the Document.
- e. Add an appropriate copyright notice for your modifications adjacent to the other copyright notices.
- f. Include, immediately after the copyright notices, a license notice giving the public permission to use the [Modified Version](#) under the terms of this License, in the form shown in the Addendum below.
- g. Preserve in that license notice the full lists of [Invariant Sections](#) and required [Cover Texts](#) given in the Document's license notice.
- h. Include an unaltered copy of this License.
- i. Preserve the section Entitled "History", Preserve its Title, and add to it an item stating at least the title, year, new authors, and publisher of the [Modified Version](#) as given on the [Title Page](#). If there is no section Entitled "History" in the Document, create one stating the title, year, authors, and publisher of the Document as given on its [Title Page](#), then add an item describing the [Modified Version](#) as stated in the previous sentence.
- j. Preserve the network location, if any, given in the Document for public access to a [Transparent](#) copy of the Document, and likewise the network locations given in the Document for previous versions it was based on. These may be placed in the "History" section. You may omit a network location for a work that was published at least four years before the Document itself, or if the original publisher of the version it refers to gives permission.
- k. For any section Entitled "Acknowledgements" or "Dedications", Preserve the Title of the section, and preserve in the section all the substance and tone of each of the contributor acknowledgements and/or dedications given therein.
- l. Preserve all the [Invariant Sections](#) of the Document, unaltered in their text and in their titles. Section numbers or the equivalent are not considered part of the section titles.

- m. Delete any section Entitled “Endorsements”. Such a section may not be included in the [Modified Version](#).
- n. Do not retitle any existing section to be Entitled “Endorsements” or to conflict in title with any [Invariant Sections](#).
- o. Preserve any Warranty Disclaimers.

If the [Modified Version](#) includes new front-matter sections or appendices that qualify as [Secondary Section](#) and contain no material copied from the Document, you may at your option designate some or all of these sections as invariant. To do this, add their titles to the list of [Invariant Sections](#) in the [Modified Version](#)’s license notice. These titles must be distinct from any other section titles.

You may add a section Entitled “Endorsements”, provided it contains nothing but endorsements of your [Modified Version](#) by various parties—for example, statements of peer review or that the text has been approved by an organization as the authoritative definition of a standard.

You may add a passage of up to five words as a Front-Cover Text, and a passage of up to 25 words as a Back-Cover Text, to the end of the list of [Cover Texts](#) in the [Modified Version](#). Only one passage of Front-Cover Text and one of Back-Cover Text may be added by (or through arrangements made by) any one entity. If the Document already includes a cover text for the same cover, previously added by you or by arrangement made by the same entity you are acting on behalf of, you may not add another; but you may replace the old one, on explicit permission from the previous publisher that added the old one.

The author(s) and publisher(s) of the Document do not by this License give permission to use their names for publicity for or to assert or imply endorsement of any [Modified Version](#).

C.6 COMBINING DOCUMENTS

You may combine the Document with other documents released under this License, under the terms defined in section 4 above for modified versions, provided that you include in the combination all of the [Invariant Sections](#) of all of the original documents, unmodified, and list them all as [Invariant Sections](#) of your combined work in its license notice, and that you preserve all their Warranty Disclaimers.

The combined work need only contain one copy of this License, and multiple identical [Invariant Sections](#) may be replaced with a single copy. If there are multiple [Invariant Sections](#) with the same name but different contents, make the title of each such section unique by adding at the end of it, in parentheses, the name of the original author or publisher of that section if known, or else a unique number. Make the same adjustment to the section titles in the list of [Invariant Sections](#) in the license notice of the combined work.

In the combination, you must combine any sections Entitled “History” in the various original documents, forming one section Entitled “History”; likewise combine any sections Entitled “Acknowledgements”, and any sections Entitled “Dedications”. You must delete all sections Entitled “Endorsements”.

C.7 COLLECTIONS OF DOCUMENTS

You may make a collection consisting of the Document and other documents released under this License, and replace the individual copies of this License in the various documents with a single copy that is included in the collection, provided that you follow the rules of this License for verbatim copying of each of the documents in all other respects.

You may extract a single document from such a collection, and distribute it individually under this License, provided you insert a copy of this License into the extracted document, and follow this License in all other respects regarding verbatim copying of that document.

C.8 AGGREGATION WITH INDEPENDENT WORKS

A compilation of the Document or its derivatives with other separate and independent documents or works, in or on a volume of a storage or distribution medium, is called an “aggregate” if the copyright resulting from the compilation is not used to limit the legal rights of the compilation’s users beyond what the individual works permit. When the Document is included in an aggregate, this License does not apply to the other works in the aggregate which are not themselves derivative works of the Document.

If the Cover Text requirement of section 3 is applicable to these copies of the Document, then if the Document is less than one half of the entire aggregate, the Document's **Cover Texts** may be placed on covers that bracket the Document within the aggregate, or the electronic equivalent of covers if the Document is in electronic form. Otherwise they must appear on printed covers that bracket the whole aggregate.

C.9 TRANSLATION

Translation is considered a kind of modification, so you may distribute translations of the Document under the terms of section 4. Replacing **Invariant Sections** with translations requires special permission from their copyright holders, but you may include translations of some or all **Invariant Sections** in addition to the original versions of these **Invariant Sections**. You may include a translation of this License, and all the license notices in the Document, and any Warranty Disclaimers, provided that you also include the original English version of this License and the original versions of those notices and disclaimers. In case of a disagreement between the translation and the original version of this License or a notice or disclaimer, the original version will prevail.

If a section in the Document is Entitled "Acknowledgements", "Dedications", or "History", the requirement (section 4) to Preserve its Title (section 1) will typically require changing the actual title.

C.10 TERMINATION

You may not copy, modify, sublicense, or distribute the Document except as expressly provided under this License. Any attempt otherwise to copy, modify, sublicense, or distribute it is void, and will automatically terminate your rights under this License.

However, if you cease all violation of this License, then your license from a particular copyright holder is reinstated (a) provisionally, unless and until the copyright holder explicitly and finally terminates your license, and (b) permanently, if the copyright holder fails to notify you of the violation by some reasonable means prior to 60 days after the cessation.

Moreover, your license from a particular copyright holder is reinstated permanently if the copyright holder notifies you of the violation by some reasonable means, this is the first time you have received notice of violation of this License (for any work) from that copyright holder, and you cure the violation prior to 30 days after your receipt of the notice.

Termination of your rights under this section does not terminate the licenses of parties who have received copies or rights from you under this License. If your rights have been terminated and not permanently reinstated, receipt of a copy of some or all of the same material does not give you any rights to use it.

C.11 FUTURE REVISIONS OF THIS LICENSE

The Free Software Foundation may publish new, revised versions of the GNU Free Documentation License from time to time. Such new versions will be similar in spirit to the present version, but may differ in detail to address new problems or concerns. See <http://www.gnu.org/copyleft/>.

Each version of the License is given a distinguishing version number. If the Document specifies that a particular numbered version of this License "or any later version" applies to it, you have the option of following the terms and conditions either of that specified version or of any later version that has been published (not as a draft) by the Free Software Foundation. If the Document does not specify a version number of this License, you may choose any version ever published (not as a draft) by the Free Software Foundation. If the Document specifies that a proxy can decide which future versions of this License can be used, that proxy's public statement of acceptance of a version permanently authorizes you to choose that version for the Document.

C.12 RELICENSING

"Massive Multiauthor Collaboration Site" (or "MMC Site") means any World Wide Web server that publishes copyrightable works and also provides prominent facilities for anybody to edit those works. A public wiki that anybody can edit is an example of such a server. A "Massive Multiauthor Collaboration" (or "MMC") contained in the site means any set of copyrightable works thus published on the MMC site.

"CC-BY-SA" means the Creative Commons Attribution-Share Alike 3.0 license published by Creative Commons Corporation, a not-for-profit corporation with a principal place of business in San Francisco, California, as well as future copyleft versions of that license published by that same organization.

“Incorporate” means to publish or republish a Document, in whole or in part, as part of another Document.

An MMC is “eligible for relicensing” if it is licensed under this License, and if all works that were first published under this License somewhere other than this MMC, and subsequently incorporated in whole or in part into the MMC, (1) had no cover texts or invariant sections, and (2) were thus incorporated prior to November 1, 2008.

The operator of an MMC Site may republish an MMC contained in the site under CC-BY-SA on the same site at any time before August 1, 2009, provided the MMC is eligible for relicensing.

C.13 ADDENDUM: How to use this License for your documents

To use this License in a document you have written, include a copy of the License in the document and put the following copyright and license notices just after the title page:

```
Copyright (c) YEAR YOUR NAME.
Permission is granted to copy, distribute and/or modify this document
under the terms of the GNU Free Documentation License, Version 1.3
or any later version published by the Free Software Foundation;
with no Invariant Sections, no Front-Cover Texts, and no Back-Cover Texts.
A copy of the license is included in the section entitled ``GNU
Free Documentation License''.
```

If you have [Invariant Sections](#), [Front-Cover Texts](#) and [Back-Cover Texts](#), replace the “with... Texts.” line with this:

```
with the Invariant Sections being LIST THEIR TITLES, with the
Front-Cover Texts being LIST, and with the Back-Cover Texts being LIST.
```

If you have [Invariant Sections](#) without [Cover Texts](#), or some other combination of the three, merge those two alternatives to suit the situation.

If your document contains nontrivial examples of program code, we recommend releasing these examples in parallel under your choice of free software license, such as the GNU General Public License, to permit their use in free software.